

Serrated Soft Top Jaws

Page



Blank Jaws

• With or without bolt holes • 60° or 90° serrations • Steel or Aluminium

7 - 9

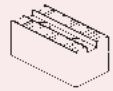

Standard Jaws

• For power chucks • 60° or 90° serrations • Steel or Aluminium

10 - 41



Long Pointed Jaws

• For power chucks • 60° or 90° serrations • Steel or Aluminium

10 - 41

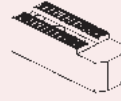

Front Relieved Pointed Jaws

• For power chucks • 2 or 3 bolt holes • 60° or 90° serrations • Steel

10 - 41

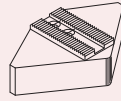

Diamond Jaws

• For power chucks • 60° or 90° serrations • Steel or Aluminium

10 - 35

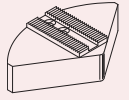

Segment Jaws

• For power chucks • 60° or 90° serrations • Steel or Aluminium

10 - 35

	Blank Jaws Steel or Aluminium	Standard & large Jaws	Long Pointed Jaws	Front Relieved Pointed Jaws	Diamond or Segment Jaws Steel or Aluminium
	Page	Page	Page	Page	Page
AUTOBLOK	7-9	28-29, 32-33, 40-41	28-29, 32-33		28-29, 32-35
AUTOSTRONG	7-9	10-11, 14-15, 18-19 22-23	10-11, 14-15, 18-19		10-11, 14-15, 18-19 22-23
BERG	7-9	28-29, 32-33, 36	28-29, 32-33		28-29, 32-35
FORKARDT	7-9	28-29, 32-33, 40-41	28-29, 32-33		28-29, 32-35
GAMET	7-9	26-27, 28-29, 32-33	28-29, 32-33	26-27, 38	28-29, 32-35
HARDINGE	7-9	10-11, 14-15, 18-19	10-11, 14-15, 18-19		10-11, 14-15, 18-19
HERBERT COVENTRY		39			
HOWA	7-9	10-11, 14-15, 18-19 26	10-11, 14-15, 18-19		10-11, 14-15, 18-19
KITAGAWA	7-9	10-11, 14-15, 18-19 22-23	10-11, 14-15, 18-19		10-11, 14-15, 18-19 22-23
LEADER	7-9	10-11, 14-15, 18-19	10-11, 14-15, 18-19		10-11, 14-15, 18-19
MMK MATSUMOTO	7-9	10-11, 14-15, 18-19 22-23	10-11, 14-15, 18-19	10-11, 14-15	10-11, 14-15, 18-19 22-23
NIKKO				26-27	
PRATT BURNERD	7-9	12-13, 16-17, 20-21, 24-25, 30-31, 34-35 37, 39	12-13, 16-17, 20-21 30-31, 34-35		12-13, 16-17, 20-21 24-25, 30-31, 34-35
RÖHM	7-9	12-13, 16-17, 20-21 26-27, 30-31, 34-35 37, 40-41	12-13, 16-17, 20-21 26-27, 30-31, 34-35		12-13, 16-17, 20-21 30-31, 34-35
SAMCHULLY	7-9	12-13, 16-17, 20-21 24-25	12-13, 16-17, 20-21		12-13, 16-17, 20-21 24-25
SCHUNK	7-9	12-13, 16-17, 20-21, 24-25 30-31, 34-35, 37-38 40-41	12-13, 16-17, 20, 21 30-31, 34-35		12-13, 16-17, 20-21, 24-25 30-31, 34-35
SEOAM	7-9	12-13, 16-17, 20-21 24-25	12-13, 16-17, 20-21		12-13, 16-17, 20-21, 24-25
SMW	7-9	30-31, 34-35, 38, 40-41	30-31, 34-35		30-31, 34-35
SMW-AUTOBLOK	7-9	12-13, 16-17, 20-21 28-29, 32-33, 36, 38 40-41	12-13, 16-17, 20-21 28-29, 32-33		28-29, 32-33
TONFOU	7-9	12-13, 16-17, 20-21 24-25	12-13, 16-17, 20-21		12-13, 16-17, 20-21 24-25

THAME WORKHOLDING

Field End, Thame Road, Long Crendon, Aylesbury, Bucks, HP18 9EJ England
 Telephone: + 44 (0)1844 208050 Fax: + 44 (0)1844 201699
 E-mail: sales@thameworkholding.com Web: www.thameworkholding.com

Serrated Top Jaw and Chuck Data Sheet

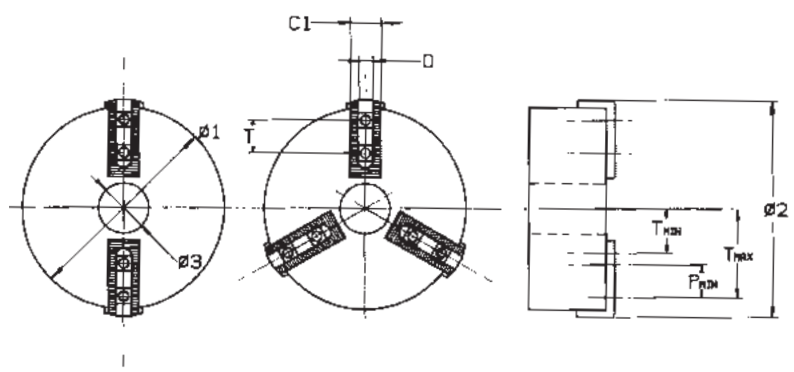

		2 JAW CHUCK DATA	3 JAW CHUCK DATA	REMARKS
Chuck Manufacturer / Model No.				
Chuck ϕ / Type	$\phi 1$			
Maximum Swing ϕ	$\phi 2$			
Chuck Bore	$\phi 3$			
Base Jaw Width	C1			
T-Nut Minimum Position	Tmin			
T-Nut Maximum Position	Tmax			
T-Nuts Minimum Hole Pitch	Pmin			
Are Base Jaw Serrations Above Chuck Face	Yes			
	No			
Are T-Nuts Single or Double	Single			
	Double			
Slot Width	D			
Hole Centre Spacing	K			
Hole Centre To Back of Jaw	J			
Counterbore / Hole ϕ	G/F			
Depth Under Bolt Head	X			
Serration Pitch & Angle	L			
Length Of Jaw	A			
Height Of Jaw	B			
Width Of Jaw	C			

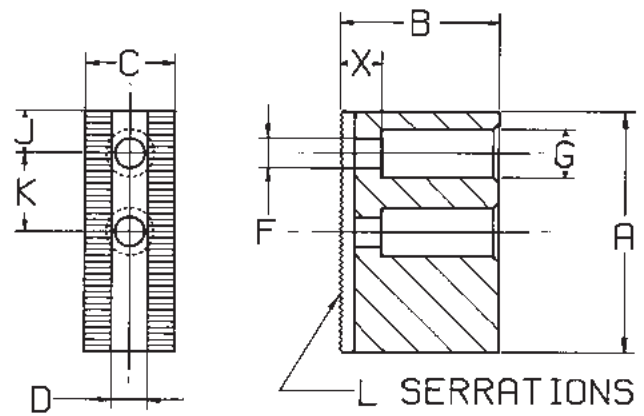

THAME WORKHOLDING

Field End, Thame Road, Long Crendon, Aylesbury, Bucks, HP18 9EJ England
 Telephone: + 44 (0)1844 208050 Fax: + 44 (0)1844 201699
 E-mail: sales@thameworkholding.com Web: www.thameworkholding.com

Serrated Soft Top Jaws 60° SERRATIONS - WITH OR WITHOUT BOLT HOLES

Material:

- Carbon Case Hardening Steel, 080M15 (En32)
- Black Finish

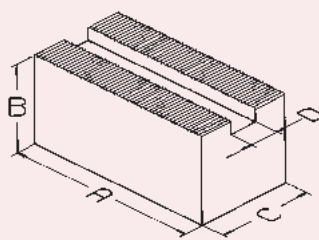

WITHOUT BOLT HOLES

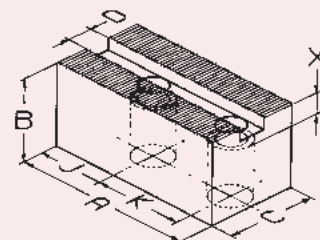

DRILLED

Serrated Steel Blanks 1.5mm x 60°

THAME PART No.	SERRATIONS	A	B	C	D	WEIGHT Kg/Set	DRILLED TO SUIT BOLT	J, K & X
HJ 02	1.5mm x 60°	72	35	30	12	1.9	M10	Please specify or state chuck to suit
HJ 03		72	60	30		3.0		
HJ 04		72	80	30		4.0		
HJ 05		60	50	50		3.4		
HJ 06		82	30	30		1.5		
HK 01		1.5mm x 60°	90	35		35		
HK 02	90		60	35	3.7			
HK 03	95		80	35	4.9			
HK 04	95		100	35	7.2			
HK 06	102		40	35	3.3			
HK 07	75		50	65	5.6			
HM 02	1.5mm x 60°		84	40	40	16	3.1	M12
HM 03		110	40	40	4.1			
HM 04		90	60	40	5.0			
HM 05		110	60	40	6.2			
HM 06		110	80	40	7.8			
HM 07		110	100	40	10.3			
HM 08		110	125	40	12.9			
HM 09		90	50	80	8.2			
HM 10		125	40	40	4.8			
HO 02		1.5mm x 60°	130	50	50		18	
HO 03	130		80	50	11.7			
HO 05	130		100	50	15.7			
HO 06	130		125	50	19.7			
HO 07	145		50	50	8.2			
HS 01	1.5mm x 60°	130	50	50	21	7.6	M16	Please specify or state chuck to suit
HS 02		130	80	50		11.5		
HS 03		130	100	50		15.5		
HS 04		130	125	50		19.5		
HS 05		145	50	50		8.2		

THAME WORKHOLDING

Field End, Thame Road, Long Crendon, Aylesbury, Bucks, HP18 9EJ England
 Telephone: + 44 (0)1844 208050 Fax: + 44 (0)1844 201699
 E-mail: sales@thameworkholding.com Web: www.thameworkholding.com

Serrated Soft Top Jaws

90° SERRATIONS - WITH OR WITHOUT BOLT HOLES

Material:

- Carbon Case Hardening Steel, 080M15 (En32)
- Black Finish

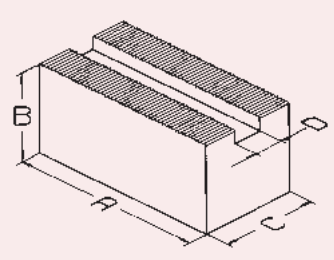

WITHOUT BOLT HOLES

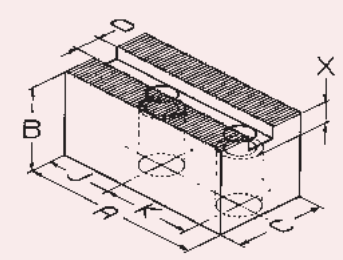

DRILLED

Serrated Steel Blanks 1/16" x 90°

THAME PART No.	SERRATIONS	A	B	C	D	WEIGHT Kg/Set	DRILLED TO SUIT BOLT	J, K & X
FJ 02	1/16" x 90°	80	50	40	17	3.7	M12	Please specify or state chuck to suit
FJ 03		98	50	40		4.7		
FJ 04		70	60	40		3.8		
FJ 05		90	60	40		4.9		
FJ 06		110	60	40		6.2		
FJ 07		90	80	40		6.4		
FJ 08		90	40	40		3.2		
FJ 09		90	50	80		8.7		
FJ 10		90	100	40		8.7		
FL 01		1/16" x 90°	90	50	50	21		
FL 02	120		50	50		6.7		
FL 03	140		50	50		8.5		
FL 04	170		65	50		12.9		
FL 06	120		80	50		10.9		
FL 07	120		100	50		14.6		
FL 09	95		70	70		11.0		
FL 10	120		76	101		21.8		
FL 11	120		125	50		17.6		

Serrated Steel Blanks 3/32" x 90°

THAME PART No.	SERRATIONS	A	B	C	D	WEIGHT Kg/Set	DRILLED TO SUIT BOLT	J, K & X
FN 01	3/32" x 90°	140	60	60	25.5	12.3	M20	Please specify or state chuck to suit
FN 04		155	90	60		19.5		
FN 05		150	125	60		27.4		
FN 06		150	80	80		22.6		

Serrated Soft Top Jaws 60° & 90° SERRATIONS - WITH OR WITHOUT BOLT HOLES

Material:

- Aluminium: HE30TF
- Natural Finish

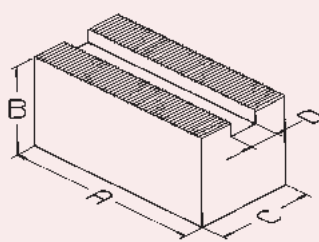

WITHOUT BOLT HOLES

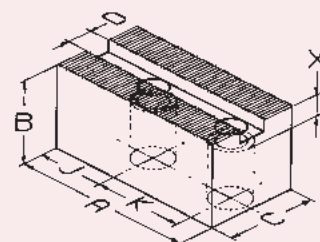

DRILLED

Serrated Aluminium Blanks 1.5mm x 60°

THAME PART No.	SERRATIONS	A	B	C	D	WEIGHT Kg/Set	DRILLED TO SUIT BOLT	J, K & X
HP 01	1.5mm x 60°	72	38	32	12	0.7	M10	Please specify or state chuck to suit
HP 02		72	76	32		1.4		
HP 05	1.5mm x 60°	95	44	32	14	1.1	M12	
HP 06		95	76	32		1.9		
HP 07		95	102	32		2.5		
HP 11	1.5mm x 60°	110	51	38	16	1.7	M12	
HP 12		110	76	38		2.5		
HP 13		110	102	38		3.3		
HP 17	1.5mm x 60°	130	51	51	18	2.7	M14	
HP 18		130	76	51		4.1		
HP 19		130	102	51		5.4		
HP 25	1.5mm x 60°	130	51	51	21	2.5	M16	
HP 26		130	76	51		4.0		
HP 27		130	102	51		5.2		

Serrated Aluminium Blanks 1/16" x 90°

THAME PART No.	SERRATIONS	A	B	C	D	WEIGHT Kg/Set	DRILLED TO SUIT BOLT	J, K & X
HR 01	1/16" X 90	70	51	38	17	1.1	M12	Please specify or state chuck to suit
HR 02		90	76	38		2.1		
HR 03		90	102	38		2.8		
HR 06	1/16" X 90	120	51	51	21	2.5	M16	
HR 07		120	76	51		3.8		
HR 08		120	102	51		5.0		

THAME WORKHOLDING

Field End, Thame Road, Long Crendon, Aylesbury, Bucks, HP18 9EJ England
 Telephone: + 44 (0)1844 208050 Fax: + 44 (0)1844 201699
 E-mail: sales@thameworkholding.com Web: www.thameworkholding.com

Serrated Soft Top Jaws

60° SERRATIONS

Material:

- Steel: 080M15 (En32) • Black Finish
- Aluminium: HE30TF • Natural Finish

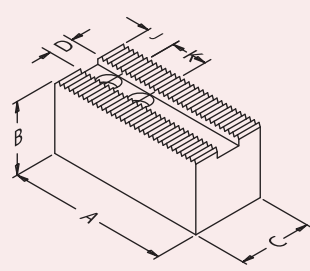

TYPE: **AS** - STEEL **AA** - ALUMINIUM

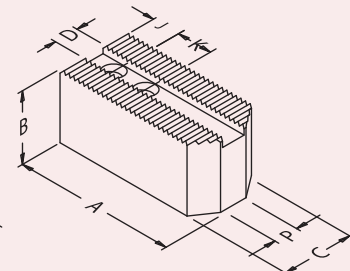

TYPE: **BS** - STEEL

Chuck Ø 110mm - 210mm

THAME PART No.	JAW TYPE	A	B	C	D	K&J BOLT	P	SERRATIONS	WEIGHT Kg/Set
BO 04	BS	48	25	20	8	15+8 M6	4	1.5mm x 60°	0.5
BR 04	BS	45	25	25	10	14+13 M8	4	1.5mm x 60°	0.3
BB 04	BS	45	40	25	10	14+13 M8	4		0.5
BR 05	BS	55	25	25	10	14+13 M8	4		0.6
BB 05	BS	55	40	25	10	14+13 M8	4		1.0
DK 05	AS	55	50	25	10	14+13 M8			1.1
BH 05	AS	55	60	25	10	14+13 M8			1.4
HN 12	DA	50	50	100	10	14+13 M8			3.5
BO 05	BS	57	35	25	10	18+10 M8	4	1.5mm x 60°	0.9
DJ 05	AS	57	50	25	10	18+10 M8			1.3
CK 05	BS	62	25	25	10	19+8 M8	4	1.5mm x 60°	0.9
DU 05	AS	48	25	25	11	16+9.5 M8		1.5mm x 60°	0.7
CK 06	CS	80	35	30	11	25+14 M8	8	1.5mm x 60°	1.4
BX 12	BS	60	35	30	12	16+15 M10	8	1.5mm x 60°	1.2
BX 13	AS	52	25	25	12	14+8 M8		1.5mm x 60°	0.8
BX 17	AS	70	30	30	12	17+11 M10		1.5mm x 60°	1.1
BO 06	AS	72	35	30	12	20+15 M10		1.5mm x 60°	1.3
AA 06	AA	72	38	32	12	20+15 M10			0.7
BA 06	BS	72	30	30	12	20+15 M10	5		1.0
BQ 06	AS	72	30	30	12	20+15 M10			1.1
BB 06	AS	72	40	30	12	20+15 M10			1.5
BC 06	AS	72	50	30	12	20+15 M10			1.8
DJ 06	AS	72	60	30	12	20+15 M10			2.2
AB 06	AA	72	76	32	12	20+15 M10			1.4
PT 06	BS	82	30	30	12	20+15 M10	5		1.3
CN 16	DS	60	60	120	12	20+15 M10			9.0
HN 16	DA	64	64	120	12	20+15 M10			3.2
HN 17	DA	64	100	120	12	20+15 M10			5.0
SG 06	ES	76	76	Ø169	12	20+20 M10			13.0
AG 06	EA	76	76	Ø169	12	20+20 M10			6.0
BD 06	FS	72	60	30	12	20+15 M10	5		1.8

THAME WORKHOLDING

Field End, Thame Road, Long Crendon, Aylesbury, Bucks, HP18 9EJ England
 Telephone: + 44 (0)1844 208050 Fax: + 44 (0)1844 201699
 E-mail: sales@thameworkholding.com Web: www.thameworkholding.com

IMPORTANT: Allow for weight of Large Diamond/Segment Jaws at high R.P.M.'s as the grip loss due to the effect of centrifugal forces will be greater.

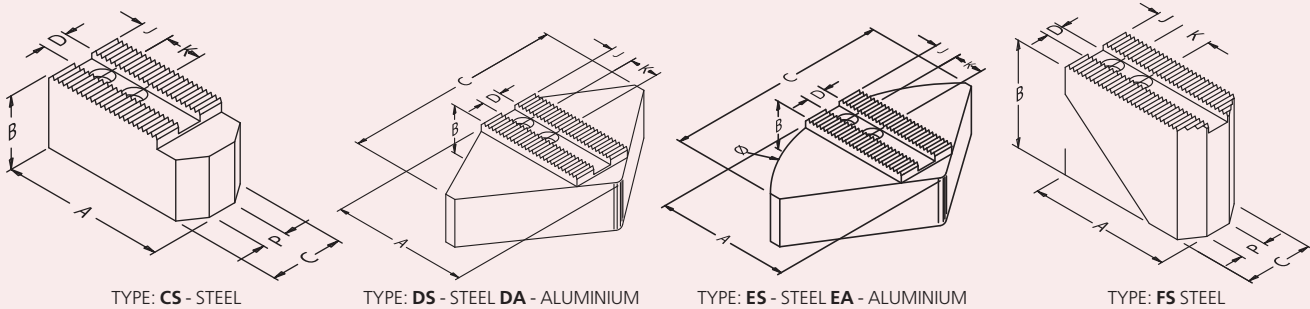

AUTOSTRONG	HARDINGE (SURE GRIP)	HOWA	KITAGAWA	LEADER	MATSUMOTO (MMK)
N204;N205;NT205	4" SURE-GRIP 5" SURE-GRIP	HO1MA4 HO24M5	B04; HOB-4 B204; N-04; BT204; AS04 B205; BT205; AS110 HJA-4; HL04; NT04		H-4-21; Z-4-21 Z-5-34 PC-5-34
			HOB-5; B-05		
		HO1MA5	HJA-5; N-05; NT05		HXA5-6-34 HHXA5-6 ZA5-6-40
		HO27M4 HO27M5			HA5-6; HH-6; HX-6; HJ-6; H-6; STC-6 ZA-5-6
N206;V206;NT206 NB206	6" SURE-GRIP	HO7MA6; HO15MA6 HO22M6; HO24M6 HO27M6; HO37M6 HO47M6; HO23M8 H3KT6	HJA5-6; HOS-6; N-06 HOB-6; AS-165; B206 B-160; HO-06; B-06; NL06 BB-06; BT206; HOH-160 HOH-206; HOH-06; B-07 N-160; B-106; BL206 BB206; BS306; BLT206; NLT06; DL06; ML06; HW08; BT-06	LC165 KHF 165	PC-6-46

THAME WORKHOLDING

Field End, Thame Road, Long Crendon, Aylesbury, Bucks, HP18 9EJ England
 Telephone: + 44 (0)1844 208050 Fax: + 44 (0)1844 201699
 E-mail: sales@thameworkholding.com Web: www.thameworkholding.com

Serrated Soft Top Jaws

60° SERRATIONS

Material:

- Steel: 080M15 (En32) • Black Finish
- Aluminium: HE30TF • Natural Finish

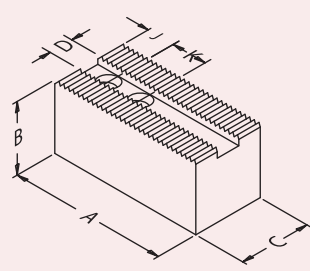

TYPE: **AS** - STEEL **AA** - ALUMINIUM

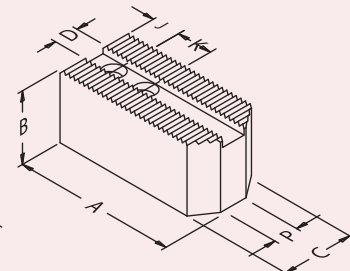

TYPE: **BS** - STEEL

Chuck Ø 110mm - 210mm

THAME PART No.	JAW TYPE	A	B	C	D	K&J BOLT	P	SERRATIONS	WEIGHT Kg/Set
BO 04	BS	48	25	20	8	15+8 M6	4	1.5mm x 60°	0.5
BR 04	BS	45	25	25	10	14+13 M8	4	1.5mm x 60°	0.3
BB 04	BS	45	40	25	10	14+13 M8	4		0.5
BR 05	BS	55	25	25	10	14+13 M8	4		0.6
BB 05	BS	55	40	25	10	14+13 M8	4		1.0
DK 05	AS	55	50	25	10	14+13 M8			1.1
BH 05	AS	55	60	25	10	14+13 M8			1.4
HN 12	DA	50	50	100	10	14+13 M8			3.5
BO 05	BS	57	35	25	10	18+10 M8	4	1.5mm x 60°	0.9
DJ 05	AS	57	50	25	10	18+10 M8			1.3
CK 05	BS	62	25	25	10	19+8 M8	4	1.5mm x 60°	0.9
DU 05	AS	48	25	25	11	16+9.5 M8		1.5mm x 60°	0.7
CK 06	CS	80	35	30	11	25+14 M8	8	1.5mm x 60°	1.4
BX 12	BS	60	35	30	12	16+15 M10	8	1.5mm x 60°	1.2
BX 13	AS	52	25	25	12	14+8 M8		1.5mm x 60°	0.8
BX 17	AS	70	30	30	12	17+11 M10		1.5mm x 60°	1.1
BO 06	AS	72	35	30	12	20+15 M10		1.5mm x 60°	1.3
AA 06	AA	72	38	32	12	20+15 M10			0.7
BA 06	BS	72	30	30	12	20+15 M10	5		1.0
BQ 06	AS	72	30	30	12	20+15 M10			1.1
BB 06	AS	72	40	30	12	20+15 M10			1.5
BC 06	AS	72	50	30	12	20+15 M10			1.8
DJ 06	AS	72	60	30	12	20+15 M10			2.2
AB 06	AA	72	76	32	12	20+15 M10			1.4
PT 06	BS	82	30	30	12	20+15 M10	5		1.3
CN 16	DS	60	60	120	12	20+15 M10			9.0
HN 16	DA	64	64	120	12	20+15 M10			3.2
HN 17	DA	64	100	120	12	20+15 M10			5.0
SG 06	ES	76	76	Ø169	12	20+20 M10			13.0
AG 06	EA	76	76	Ø169	12	20+20 M10			6.0
BD 06	FS	72	60	30	12	20+15 M10	5		1.8

THAME WORKHOLDING

Field End, Thame Road, Long Crendon, Aylesbury, Bucks, HP18 9EJ England
 Telephone: + 44 (0)1844 208050 Fax: + 44 (0)1844 201699
 E-mail: sales@thameworkholding.com Web: www.thameworkholding.com

IMPORTANT: Allow for weight of Large Diamond/Segment Jaws at high R.P.M.'s as the grip loss due to the effect of centrifugal forces will be greater.

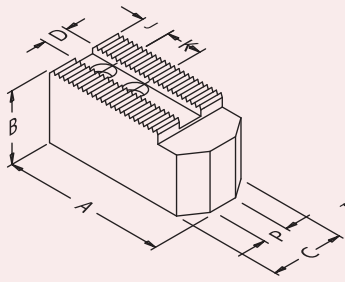

TYPE: **CS** - STEEL

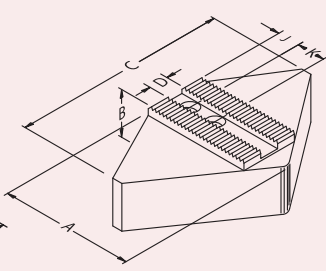

TYPE: **DS** - STEEL **DA** - ALUMINIUM

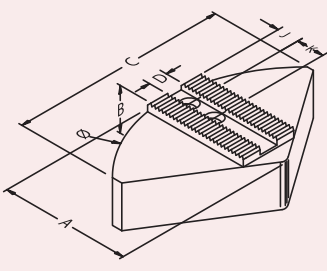

TYPE: **ES** - STEEL **EA** - ALUMINIUM

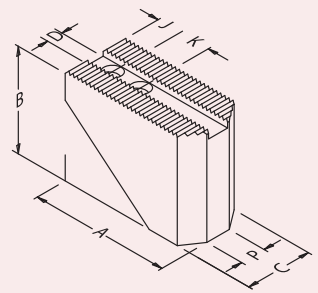

TYPE: **FS** STEEL

PRATT BURNERD	RÖHM	SAMCHULLY (POWER GRIP)	SEOAM (ACE)	SCHUNK	SMW-AUTOBLOK	TONFOU
		HCH-04				
	KFD-HE 130; KFN 105	HC-04 HS-04 HS-05	CAS-4; CAH-5			TF3B-04; TF38-05
		HCH-05	CAS-5			
		HC-05				
					AN-M 125; AL-M 125; PB-M 130; PB1-M 130; BH-M 130; BB-M 140	
125 INTERNATIONAL 150 KING BORE						
165 INTERNATIONAL 170 KING BORE						
165 CONSTANT GRIP 170 INTERNATIONAL 165 HIGH SPEED Q C	KFD-HE 170	HCH-06; HC06 HS-06 HH206 MH206	CAH-6; CAS-6 CGH-6	ROTA NCD 165-185; ROTA NCK 165 ROTA NC/NCF 165; HSL 165; ROTA NCK plus 165; ROTA NC plus 185; ROTA NCF 185	AL-M 165; AN-M 165; BB-M 175; BH-M 165; BH-M FC 165; HB-M 165 HFKN-M 165; PB-M 165; PBI-M 165; AP-M 170; NT-M 170; RC-M165	TF3B-06; TF3X-6 VA-206; VT-206

THAME WORKHOLDING

Field End, Thame Road, Long Crendon, Aylesbury, Bucks, HP18 9EJ England
 Telephone: + 44 (0)1844 208050 Fax: + 44 (0)1844 201699
 E-mail: sales@thameworkholding.com Web: www.thameworkholding.com

Serrated Soft Top Jaws

60° SERRATIONS

Material:

- Steel: 080M15 (En32) • Black Finish
- Aluminium: HE30TF • Natural Finish

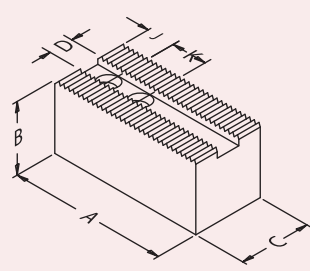

TYPE: **AS** - STEEL **AA** - ALUMINIUM

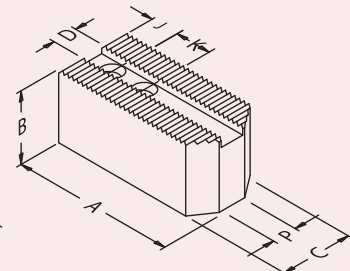

TYPE: **BS** - STEEL

Chuck Ø 210mm - 265mm

THAME PART No.	JAW TYPE	A	B	C	D	K&J BOLT	P	SERRATIONS	WEIGHT Kg/Set
BQ 08	AS	90	35	35	14	25+20 M12		1.5mm x 60°	2.2
BO 08	AS	95	40	35	14	25+25 M12			2.7
AA 08	AA	95	44	32	14	25+25 M12			1.1
BA 08	BS	95	35	35	14	25+25 M12	5		2.4
BB 08	AS	95	50	35	14	25+25 M12			3.4
BC 08	AS	95	60	35	14	25+25 M12			4.0
DJ 08	AS	95	80	35	14	25+25 M12			5.4
AB 08	AA	95	76	32	14	25+25 M12			1.9
AC 08	AA	95	102	32	14	25+25 M12			2.5
CK 08	CS	85	40	35	14	25+20 M12	15		2.2
CK 09	CS	95	40	35	14	25+20 M12	15		2.7
PT 08	BS	102	40	35	14	25+20 M12	5		2.9
CN 20	DS	89	64	150	14	25+15 M12			14.0
HN 20	DA	76	64	150	14	25+15 M12			5.0
HN 21	DA	76	100	150	14	25+15 M12			7.8
SG 08	ES	99	76	Ø210	14	25+25 M12			20.0
AG 08	EA	99	76	Ø210	14	25+25 M12		9.8	
DU 08	AS	85	40	40	16	25+20 M12		1.5mm x 60°	2.8
DU 09	AS	85	60	40	16	25+20 M12			4.0
BO 10	AS	110	40	40	16	30+30 M12		1.5mm x 60°	3.4
AA 10	AA	110	51	38	16	30+30 M12			1.7
BA 10	BS	110	40	40	16	30+30 M12	5		3.1
BR 10	AS	110	60	40	16	30+30 M12			4.5
DJ 10	AS	110	80	40	16	30+30 M12			6.5
BD 10	AS	110	100	40	16	30+30 M12			8.5
AB10	AA	110	76	38	16	30+30 M12			2.5
AC 10	AA	110	102	38	16	30+30 M12			3.3
PT 10	BS	125	40	40	16	30+30 M12	5		4.5
DK 10	AS	90	60	40	16	30+21 M12			4.2
DK 11	CS	110	60	40	16	30+21 M12	10		5.2
CN 25	DS	102	64	170	16	30+20 M12			20.0
HN 25	DA	102	64	170	16	30+20 M12			7.0
HN 26	DA	102	100	170	16	30+20 M12			10.9
SG 10	ES	122	76	Ø254	16	30+27 M12			29.0
AG 10	EA	122	76	Ø254	16	30+27 M12			13.0

THAME WORKHOLDING

Field End, Thame Road, Long Crendon, Aylesbury, Bucks, HP18 9EJ England
 Telephone: + 44 (0)1844 208050 Fax: + 44 (0)1844 201699
 E-mail: sales@thameworkholding.com Web: www.thameworkholding.com

IMPORTANT: Allow for weight of Large Diamond/Segment Jaws at high R.P.M.'s as the grip loss due to the effect of centrifugal forces will be greater.

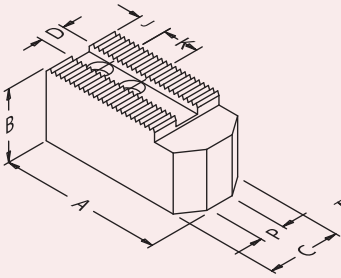

TYPE: **CS** - STEEL

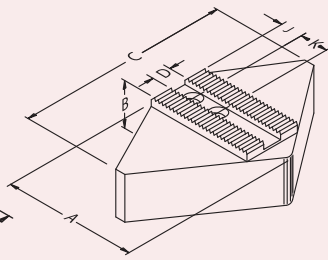

TYPE: **DS** - STEEL **DA** - ALUMINIUM

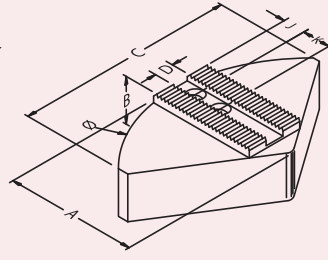

TYPE: **ES** - STEEL **EA** - ALUMINIUM

AUTOSTRONG	HARDINGE (SURE GRIP)	HOWA	KITAGAWA	LEADER	MATSUMOTO (MMK)
N208;V208;HT208; NB208	8" SURE-GRIP	HO7MA8; HO15M8	B208; B-08; HOB-8 N-200; HOH-200; N-08 HOH-8; AS-210; NL08; HOS-8; BT208; HJA6-8 HOH-208; HO-8; HOH108; B-108; BB08; BL208 BB208; HG715-210 BS308; BLT208; ML08; NLT08; DL08; UVE160K BT-08	LC210 KHF 210	HA6-8; HX-8; H-8; HH-8; HJ-8; HHJ-8; STC-8; ZA6-8-52; ZA6-8-66 PC-8-52
		HO27M8; HO47M8; HO24M8; HO22M8; HO37M8; HO7MA10; HO23M10; HO15M10			
N210;V210;NT210 NB210	10" SURE-GRIP	H3KT10	B250; B-10; HOH-250 HOH-10K; B210; HOB-10 AS-250; N-250; N-10 HJA6-10; HJ8-10; HOS-10 HO-10; NL-10; BT210 B-110; UVE-K200; HOH110 UVE-200K; HOH-210; BL210; HG730-254; B210X BB210; BS310; BLT210; BT210; NLT10; UVE250K; BT-10	LC250 KHF 250	HA6-10; HA8-10; ZA6-10-75; H-10; HX-10; HHL-10; HH-10; HHJ-10; HJ-10; HA8-11; STC-10 PC-10-78

THAME WORKHOLDING

Field End, Thame Road, Long Crendon, Aylesbury, Bucks, HP18 9EJ England
 Telephone: + 44 (0)1844 208050 Fax: + 44 (0)1844 201699
 E-mail: sales@thameworkholding.com Web: www.thameworkholding.com

Serrated Soft Top Jaws

60° SERRATIONS

Material:

- Steel: 080M15 (En32) • Black Finish
- Aluminium: HE30TF • Natural Finish

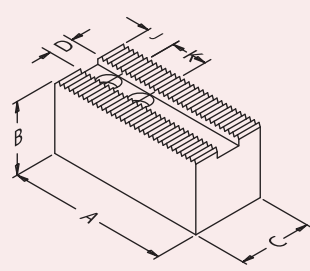

TYPE: AS- STEEL AA - ALUMINIUM

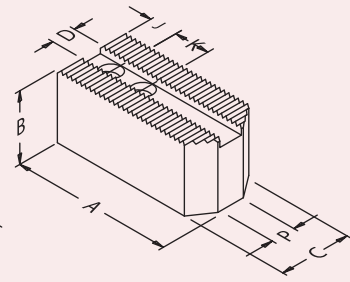

TYPE: BS - STEEL

Chuck Ø 210mm - 265mm

THAME PART No.	JAW TYPE	A	B	C	D	K&J BOLT	P	SERRATIONS	WEIGHT Kg/Set
BQ 08	AS	90	35	35	14	25+20 M12		1.5mm x 60°	2.2
BO 08	AS	95	40	35	14	25+25 M12			2.7
AA 08	AA	95	44	32	14	25+25 M12			1.1
BA 08	BS	95	35	35	14	25+25 M12	5		2.4
BB 08	AS	95	50	35	14	25+25 M12			3.4
BC 08	AS	95	60	35	14	25+25 M12			4.0
DJ 08	AS	95	80	35	14	25+25 M12			5.4
AB 08	AA	95	76	32	14	25+25 M12			1.9
AC 08	AA	95	102	32	14	25+25 M12			2.5
CK 08	CS	85	40	35	14	25+20 M12	15		2.2
CK 09	CS	95	40	35	14	25+20 M12	15		2.7
PT 08	BS	102	40	35	14	25+20 M12	5		2.9
CN 20	DS	89	64	150	14	25+15 M12			14.0
HN 20	DA	76	64	150	14	25+15 M12			5.0
HN 21	DA	76	100	150	14	25+15 M12			7.8
SG 08	ES	99	76	Ø210	14	25+25 M12			20.0
AG 08	EA	99	76	Ø210	14	25+25 M12		9.8	
DU 08	AS	85	40	40	16	25+20 M12		1.5mm x 60°	2.8
DU 09	AS	85	60	40	16	25+20 M12			4.0
BO 10	AS	110	40	40	16	30+30 M12		1.5mm x 60°	3.4
AA 10	AA	110	51	38	16	30+30 M12			1.7
BA 10	BS	110	40	40	16	30+30 M12	5		3.1
BR 10	AS	110	60	40	16	30+30 M12			4.5
DJ 10	AS	110	80	40	16	30+30 M12			6.5
BD 10	AS	110	100	40	16	30+30 M12			8.5
AB10	AA	110	76	38	16	30+30 M12			2.5
AC 10	AA	110	102	38	16	30+30 M12			3.3
PT 10	BS	125	40	40	16	30+30 M12	5		4.5
DK 10	AS	90	60	40	16	30+21 M12			4.2
DK 11	CS	110	60	40	16	30+21 M12	10		5.2
CN 25	DS	102	64	170	16	30+20 M12			20.0
HN 25	DA	102	64	170	16	30+20 M12			7.0
HN 26	DA	102	100	170	16	30+20 M12			10.9
SG 10	ES	122	76	Ø254	16	30+27 M12			29.0
AG 10	EA	122	76	Ø254	16	30+27 M12			13.0

THAME WORKHOLDING

Field End, Thame Road, Long Crendon, Aylesbury, Bucks, HP18 9EJ England
 Telephone: + 44 (0)1844 208050 Fax: + 44 (0)1844 201699
 E-mail: sales@thameworkholding.com Web: www.thameworkholding.com

IMPORTANT: Allow for weight of Large Diamond/Segment Jaws at high R.P.M.'s as the grip loss due to the effect of centrifugal forces will be greater.

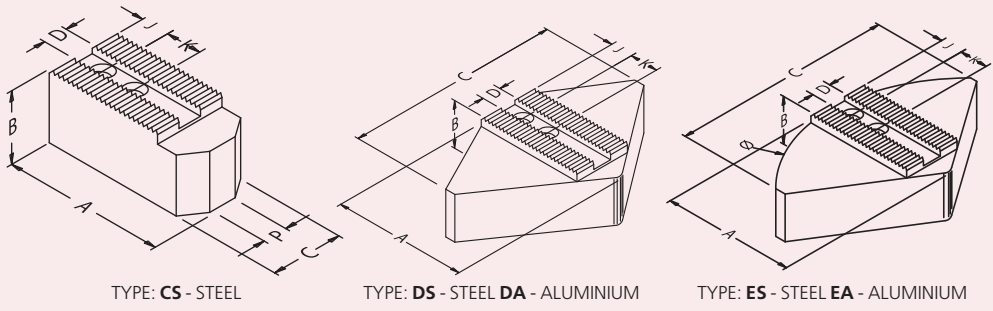

PRATT BURNERD	RÖHM	SAMCHULLY (POWER GRIP)	SEOAM (ACE)	SCHUNK	SMW-AUTOBLOK	TONFOU
210 INTERNATIONAL 210 HIGH SPEED Q C	KFD-HE 210	HCH-08; HC-08; HS-08 HH208 MH-208	CAH-8; CAS-8 CGH-8	ROTA NCD 210; ROTA NCK 210; ROTA NC/NCF 210; HSL 210; ROTA NCK plus 210; ROTA NC plus 215; ROTA NCF plus 215	AL-M 210; AN-M 210; BB-M 210; BH-M 210; BH-M FC 210; HB-M 210 HFKN-M 210; PB-M 210; PBI-M 210; AP-M 215; APL-M 215; NT-M 215 RC-M210	TF3B-08; TF3X-8 V-208; VA-208 VT-208
254 CONSTANT GRIP 254 HIGH SPEED Q C 265 INTERNATIONAL	KFD-HE 254	HCH-10; HC-10; HS-10; HH210 MH-210	CAH-10; CAS-10; CGH-10;	ROTA NCD 250; ROTA NCK 250; ROTA NC/NCF 250; HSL 250; ROTA NCK plus 250; ROTA NC plus 260; ROTA NCF plus 260	AL-M 250; AN-M 250; BB-M 250; BH-M 250; BH-M FC 250; HB-M 250; HFKN-M 260; PB-M 250; PBI-M 250; AP-M 260; APL-M 260; NT-M 260 RC-M250	TF3B-10; TF3X-10 V-210; VA-210; VT-210

Serrated Soft Top Jaws

60° SERRATIONS

Material:

- Steel: 080M15 (En32) • Black Finish
- Aluminium: HE30TF • Natural Finish

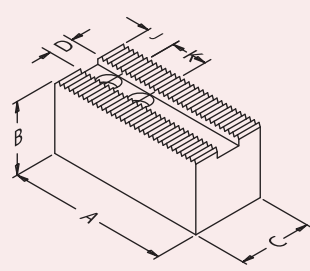

TYPE: **AS**- STEEL **AA** - ALUMINIUM

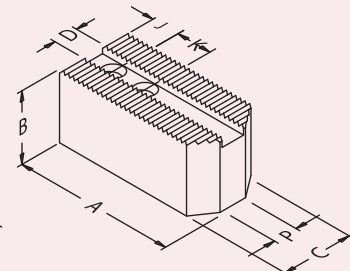

TYPE: **BS** - STEEL

Chuck Ø 265mm - 450mm

THAME PART No.	JAW TYPE	A	B	C	D	K&J BOLT	P	SERRATIONS	WEIGHT Kg/Set
DU 10	AS	105	40	40	18	30+24 M14		1.5mm x 60°	4.4
DU 11	AS	105	60	40	18	30+24 M14			6.6
BO 12	AS	130	50	50	18	30+40 M14	10	1.5mm x 60°	6.8
AA 12	AA	130	51	51	18	30+40 M14			2.7
DJ 12	AS	130	80	50	18	30+40 M14			10.9
AB 12	AA	130	76	51	18	30+40 M14			4.1
DJ 14	AS	130	100	50	18	30+40 M14			13.6
AC 12	AA	130	102	51	18	30+40 M14			5.4
PT 12	BS	145	50	50	18	30+40 M14			7.3
CN 32	DS	132	76	240	18	30+30 M14			28.0
HN 32	DA	132	76	240	18	30+30 M14			10.0
HN 30	DA	132	100	240	18	30+30 M14			13.2
SG 12	ES	146	76	Ø304	18	30+34 M14			41.0
AG 12	EA	146	76	Ø304	18	30+34 M14			15.0
BR 13	AS	130	50	50	21	30+40 M16	10	1.5mm x 60°	6.5
AA 13	AA	130	51	51	21	30+40M16			2.5
DJ 13	AS	130	80	50	21	30+40M16			10.4
BD 13	AS	130	100	50	21	30+40 M16			13.0
AB 13	AA	130	76	51	21	30+40 M16			4.0
AC 13	AA	130	102	51	21	30+40 M16			5.2
PT 13	BS	145	50	50	21	30+40 M16			7.3
CN 33	DS	132	76	240	21	30+30 M16			28.0
HN 33	DA	132	76	240	21	30+30 M16			10.0
HN 34	DA	132	100	240	21	30+30 M16			13.2
SG 13	ES	147	76	Ø304	21	30+34 M16			41.0
AG 13	EA	147	76	Ø304	21	30+34 M16			15.0
DU 12	AS	111	60	50	21	35+25 M16		1.5mm x 60°	7.1

THAME WORKHOLDING

Field End, Thame Road, Long Crendon, Aylesbury, Bucks, HP18 9EJ England
 Telephone: + 44 (0)1844 208050 Fax: + 44 (0)1844 201699
 E-mail: sales@thameworkholding.com Web: www.thameworkholding.com

IMPORTANT: Allow for weight of Large Diamond/Segment Jaws at high R.P.M.'s as the grip loss due to the effect of centrifugal forces will be greater.

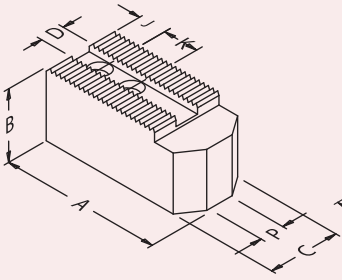

TYPE: **CS** - STEEL

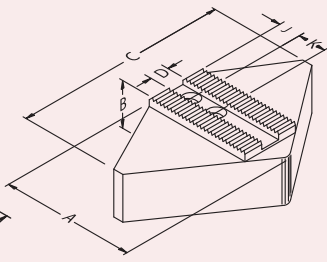

TYPE: **DS** - STEEL **DA** - ALUMINIUM

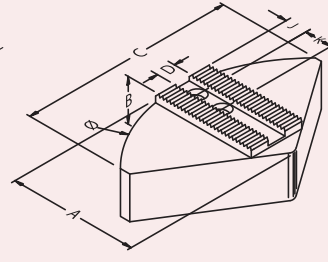

TYPE: **ES** - STEEL **EA** - ALUMINIUM

AUTOSTRONG	HARDINGE (SURE GRIP)	HOWA	KITAGAWA	LEADER	MATSUMOTO (MMK)
		H022M10; H037M10; H024M10; H027M10 H047M10; H07MA12 H023M12; H015M12			
V212			B300; B-12; HOH-300; HOH-12K; N-300; N-12; HOB-12; HJA6-12; NL-12 HLA6-12; HLA8-15; HLA6-15; NLT12 UVE315K		HA8-12; HX-12; H-12; SH-12; HH-12; HHL-12; HJ-12; HHJ-12; ZA8-12-78; ZA8-12-85 PC-12-93
N212; NT212; NB212	12" SURE-GRIP	H3KT12	B212; BT212; BL212 BB212; BLT212	LC315 KHF 315	
		H027M12; H037M12			

THAME WORKHOLDING

Field End, Thame Road, Long Crendon, Aylesbury, Bucks, HP18 9EJ England
 Telephone: + 44 (0)1844 208050 Fax: + 44 (0)1844 201699
 E-mail: sales@thameworkholding.com Web: www.thameworkholding.com

Serrated Soft Top Jaws

60° SERRATIONS

Material:

- Steel: 080M15 (En32) • Black Finish
- Aluminium: HE30TF • Natural Finish

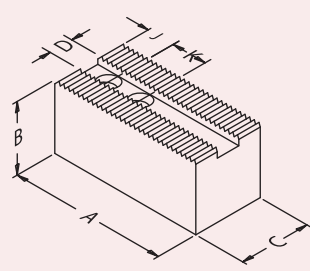

TYPE: **AS**- STEEL **AA** - ALUMINIUM

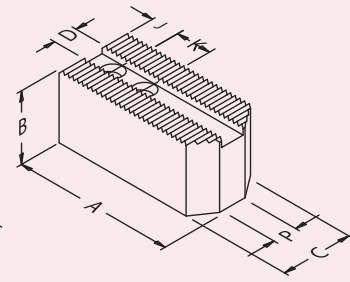

TYPE: **BS** - STEEL

Chuck Ø 265mm - 450mm

THAME PART No.	JAW TYPE	A	B	C	D	K&J BOLT	P	SERRATIONS	WEIGHT Kg/Set
DU 10	AS	105	40	40	18	30+24 M14		1.5mm x 60°	4.4
DU 11	AS	105	60	40	18	30+24 M14			6.6
BO 12	AS	130	50	50	18	30+40 M14	10	1.5mm x 60°	6.8
AA 12	AA	130	51	51	18	30+40 M14			2.7
DJ 12	AS	130	80	50	18	30+40 M14			10.9
AB 12	AA	130	76	51	18	30+40 M14			4.1
DJ 14	AS	130	100	50	18	30+40 M14			13.6
AC 12	AA	130	102	51	18	30+40 M14			5.4
PT 12	BS	145	50	50	18	30+40 M14			7.3
CN 32	DS	132	76	240	18	30+30 M14			28.0
HN 32	DA	132	76	240	18	30+30 M14			10.0
HN 30	DA	132	100	240	18	30+30 M14			13.2
SG 12	ES	146	76	Ø304	18	30+34 M14			41.0
AG 12	EA	146	76	Ø304	18	30+34 M14			15.0
BR 13	AS	130	50	50	21	30+40 M16	10	1.5mm x 60°	6.5
AA 13	AA	130	51	51	21	30+40M16			2.5
DJ 13	AS	130	80	50	21	30+40M16			10.4
BD 13	AS	130	100	50	21	30+40 M16			13.0
AB 13	AA	130	76	51	21	30+40 M16			4.0
AC 13	AA	130	102	51	21	30+40 M16			5.2
PT 13	BS	145	50	50	21	30+40 M16			7.3
CN 33	DS	132	76	240	21	30+30 M16			28.0
HN 33	DA	132	76	240	21	30+30 M16			10.0
HN 34	DA	132	100	240	21	30+30 M16			13.2
SG 13	ES	147	76	Ø304	21	30+34 M16			41.0
AG 13	EA	147	76	Ø304	21	30+34 M16			15.0
DU 12	AS	111	60	50	21	35+25 M16		1.5mm x 60°	7.1

THAME WORKHOLDING

Field End, Thame Road, Long Crendon, Aylesbury, Bucks, HP18 9EJ England
 Telephone: + 44 (0)1844 208050 Fax: + 44 (0)1844 201699
 E-mail: sales@thameworkholding.com Web: www.thameworkholding.com

IMPORTANT: Allow for weight of Large Diamond/Segment Jaws at high R.P.M.'s as the grip loss due to the effect of centrifugal forces will be greater.

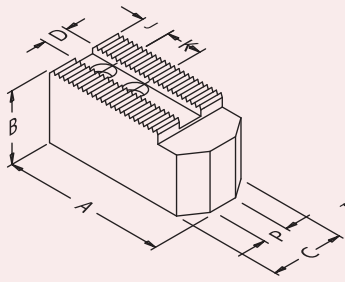

TYPE: **CS** - STEEL

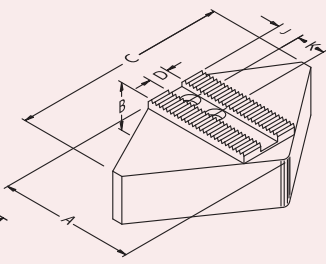

TYPE: **DS** - STEEL **DA** - ALUMINIUM

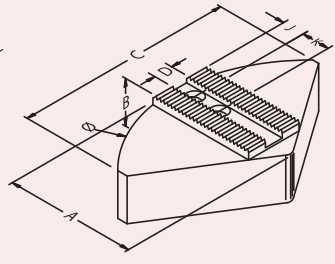

TYPE: **ES** - STEEL **EA** - ALUMINIUM

PRATT BURNERD	RÖHM	SAMCHULLY (POWER GRIP)	SEOAM (ACE)	SCHUNK	SMW-AUTOBLOK	TONFOU
305 CONSTANT GRIP 305 HIGH SPEED Q C		HC-12;HCH-12		ROTA NC/NCF 315; HSL 315		V-212;VA-212; VT-212
	KFD-HE 315	HS-12; HH212 MH-212	CAH-12	ROTA NCD 315; ROTA NCK 315; HSL 315; ROTA NCK plus 315; ROTA NC plus 315; ROTA NCF plus 315	AL-M 315; AN-M 315; BB-M 305; BB-M 315; BH-M 315; BHM-FC 315; GH-M 400; HB-M 305; HB-M 315; HFKN-M 315; PB-M 315; PBI-M 315; RC-M 305; RC-M 315; RC-M 400; AP-M 315; AP/NT-M315 APL-M315	TF3B-12

Serrated Soft Top Jaws

60° SERRATIONS

Material:

- Steel: 080M15 (En32) • Black Finish
- Aluminium: HE30TF • Natural Finish

Chuck Ø 450mm - 800mm

IMPORTANT: Allow for weight of Large Diamond/Segment Jaws at high R.P.M.'s as the grip loss due to the effect of centrifugal forces will be greater.

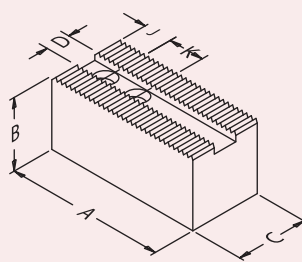

TYPE: **AS**-STEEL

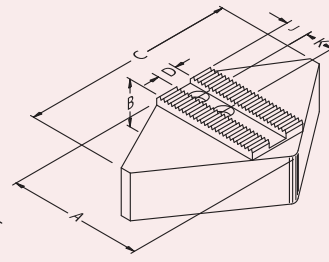

TYPE: **DS** - STEEL **DA** - ALUMINIUM

THAME PART No.	JAW TYPE	A	B	C	D	K&J BOLT	P	SERRATIONS	WEIGHT Kg/Set
BO 15	AS	165	80	60	22	43+37 M20		1.5mm x 60°	15.2
BC 15	AS	165	100	60	22	43+37 M20			19.0
DJ 15	AS	165	125	60	22	43+37 M20			24.0
BE 15	AS	145	100	100	22	43+37 M20			28.0
BF 15	AS	205	80	60	22	43+37 M20			35.0
CN 38	DS	152	76	280	22	43+37 M20			48.0
HN 38	DA	152	76	280	22	43+37 M20			16.0
HN 39	DA	152	100	280	22	43+37 M20			21.1
BR 15	AS	135	60	50	25.5	43+26 M20		1.5mm x 60°	8.2
BR 16	AS	135	100	50	25.5	43+26 M20			15.5
BO 16	AS	156	80	60	22	60+36 M20		1.5mm x 60°	14.5
CK 15	AS	150	80	60	22	50+30 M20		3mm x 60°	13.8
BO 18	AS	180	80	60	25	60+40 M20		3mm x 60°	16.5
BC 18	AS	180	100	60	25	60+40 M20			20.6
DJ 18	AS	180	125	60	25	60+40 M20			26.5
BE 18	AS	160	100	100	25	60+40 M20			31.0
BO 24	AS	210	102	76	25	80+40 M20		3mm x 60°	32.3

AUTOSTRONG	HARDINGE (SURE GRIP)	HOWA	KITAGAWA	LEADER	MATSUMOTO (MMK)
N215;NT215			B380; B-15; HOH-380; HOB-15; HOH-15K; B-450; B-18; HOB-18		PC-15-120
V215;V218			B215; N15; N18 B218; BB218		
			HJ-380; HJA-18; HLA-18; HJA-8-21; UVE400K		
					HA11-15; HHL-15; H-15; HH-15; HA11-18; H-18; HH-18; ZA8-15-120
V221;V224			HJ-450; HJ18; B-350; B-21; HJ-530; HJ-21; HOB-21; N-21; B-600; B-24; HJ-610; HJ24; N24; HOB24; UVE-LB500/630		
			HOB24; HJA24; HJ24; UVE-LB800		

THAME WORKHOLDING

Field End, Thame Road, Long Crendon, Aylesbury, Bucks, HP18 9EJ England
 Telephone: + 44 (0)1844 208050 Fax: + 44 (0)1844 201699
 E-mail: sales@thameworkholding.com Web: www.thameworkholding.com

Serrated Soft Top Jaws

60° SERRATIONS

Material:

- Steel: 080M15 (En32) • Black Finish
- Aluminium: HE30TF • Natural Finish

Chuck Ø 450mm - 800mm

IMPORTANT: Allow for weight of Large Diamond/Segment Jaws at high R.P.M.'s as the grip loss due to the effect of centrifugal forces will be greater.

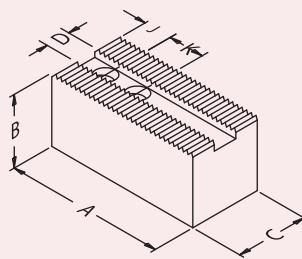

TYPE: AS-STEEL

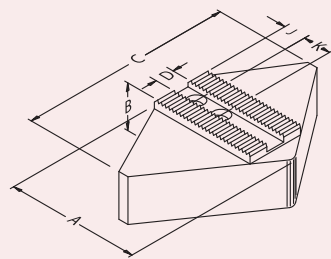

TYPE: DS - STEEL DA - ALUMINIUM

THAME PART No.	JAW TYPE	A	B	C	D	K&J BOLT	P	SERRATIONS	WEIGHT Kg/Set
BO 15	AS	165	80	60	22	43+37 M20		1.5mm x 60°	15.2
BC 15	AS	165	100	60	22	43+37 M20			19.0
DJ 15	AS	165	125	60	22	43+37 M20			24.0
BE 15	AS	145	100	100	22	43+37 M20			28.0
BF 15	AS	205	80	60	22	43+37 M20			35.0
CN 38	DS	152	76	280	22	43+37 M20			48.0
HN 38	DA	152	76	280	22	43+37 M20			16.0
HN 39	DA	152	100	280	22	43+37 M20			21.1
BR 15	AS	135	60	50	25.5	43+26 M20		1.5mm x 60°	8.2
BR 16	AS	135	100	50	25.5	43+26 M20			15.5
BO 16	AS	156	80	60	22	60+36 M20		1.5mm x 60°	14.5
CK 15	AS	150	80	60	22	50+30 M20		3mm x 60°	13.8
BO 18	AS	180	80	60	25	60+40 M20		3mm x 60°	16.5
BC 18	AS	180	100	60	25	60+40 M20			20.6
DJ 18	AS	180	125	60	25	60+40 M20			26.5
BE 18	AS	160	100	100	25	60+40 M20			31.0
BO 24	AS	210	102	76	25	80+40 M20		3mm x 60°	32.3
BO 32	AS	210	102	76	25.5	80+40 M20		3mm x 60°	32.3

PRATT BURNERD	RÖHM	SAMCHULLY (POWER GRIP)	SEOAM (ACE)	SCHUNK	SMW-AUTOBLOK	TONFOU
380 INTERNATIONAL 380 HIGH SPEED Q C		HCH-15;HCH-18	CAH-15; CAH-18;	ROTA NC/NCF 400; HSL 400	BB-M-400 (with single T-nuts)	TF3B-15
		HC-15;HS-15; HC-18				V215;VA-215 VT-215
460 CONSTANT GRIP 500 CONSTANT GRIP 610 CONSTANT GRIP 460 HIGH SPEED Q C 500 HIGH SPEED Q C 610 HIGH SPEED Q C		HC-21; HC-24; HCH-21; HCH-24	CAH-21			
		HCH-32				

Diamond/Segment Jaws



- Can be turned or bored to clamp entire circumference of workpiece
- Choice of steel or aluminium types
- Diamond Jaws have greater flexibility than segment jaws, can be reversed
- Aluminium jaws – less weight for higher spindle speeds
- Helps stop distortion of thin walled components
- Can be machined to suit irregular parts

Distortion problems can be solved by using Diamond/Segment Jaws

Serrated Soft Top Jaws

60° SERRATIONS

Material:

- Steel: 080M15 (En32) • Black Finish

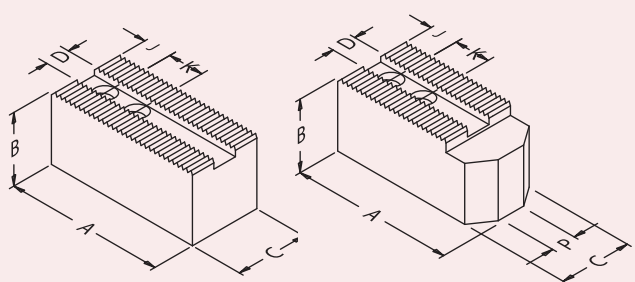

To suit • Howa HO1MA Chucks (3mm Serrations)

THAME PART No.	JAW TYPE	A	B	C	D	K&J BOLT	SERRATIONS	WEIGHT Kg/Set
BP 06	AS	72	35	30	12	20+15 M10	3mm x 60°	1.4
BP 08	AS	95	40	35	14	25+25 M12	3mm x 60°	2.6
BP 10	AS	110	40	40	16	30+30 M12	3mm x 60°	3.4
BP 12	AS	130	50	50	18	30+40 M14	3mm x 60°	6.8

To suit • Gamet • Nikko • Röhm Power Chucks

THAME PART No.	JAW TYPE	A	B	C	D	K&J BOLT	P	SERRATIONS	WEIGHT Kg/Set
DL 10	AS	50	30	20	10	15+9 M8		1.5mm x 60°	0.6
DL 16	AS	67	40	30	11	20+17 M8		1.5mm x 60°	1.6
BT 06	CS	77	35	25		20+9 M8	7		1.1
DL 22	AS	89	60	30	14	26+18 M10		1.5mm x 60°	3.1
BT 08	CS	102	40	30		22+10 M10	10		2.4
DL 28	AS	89	60	40	20	26+18 M12		1.5mm x 60°	4.1
BT 10	CS	117	50	40		30+13 M12	10		4.9
BT 11	CS	130	50	40		30+13 M12	10		5.4
DL 35	AS	120	80	50	21	28+25 M16		1.5mm x 60°	9.4
BT 14	CS	170	60	50		40+22 M16	18		10.0

THAME WORKHOLDING

Field End, Thame Road, Long Crendon, Aylesbury, Bucks, HP18 9EJ England
 Telephone: + 44 (0)1844 208050 Fax: + 44 (0)1844 201699
 E-mail: sales@thameworkholding.com Web: www.thameworkholding.com

Pointed or weight reduced soft jaws

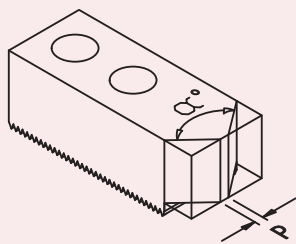

A. Pointed 60° or 120° Inclusive α°

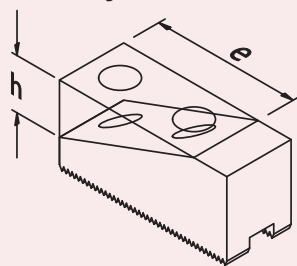

B. Rectangular Weight Reduced

Any standard soft jaw can be pointed or weight reduced, please give following information:-

1. Quantity of sets required.
2. Thame Part No.
3. Modification required.
4. Relevant dimensions.

HOWA CHUCK TYPE

HO1MA6

HO1MA8

HO1MA10

HO1MA12

Conversion plates

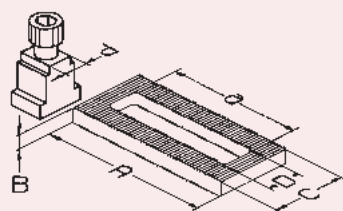

A. Serration to Serration

Allows different top jaws to be used with base jaws of another configuration. Please contact our sales office for a quotation.

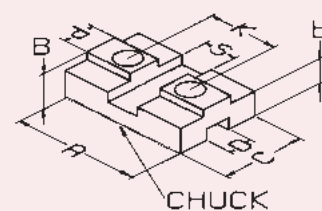

B. Serration to Slot/Tenon

GAMET		NIKKO		ROHM
105N		HF-4		KFD-HE 130
105 MO				KFN 105
140 DE	160 GO	GO-6	HDM-165	KFN 160
160 N	170 MF	H F-6AB	D-170	KFM 160
160 MO		HG-6AB		KFG 160
130 N	130MO	M0-6		KFE 170
170 DE	215 MF	GO-8	MO-8	KFN 215
215 N	MAC 165	HF-8		KFM 215
215 MO		HG-8		KFG 215
215GO		HDM 215		KFE 215
250 N		GO-10	HDM 250	KFN 250/280
280 N		GO-12	HDM 300	KFM 280
280 MO		HF-10	MO-10	KFG 280
280 GO		HF-12	MO-12	KFE 280
280 MF		HG-10		
350 N	MAC 250	HF-14	MO-14	KFN 350
350 GO	MAC 315	HF-16		KFM 350
350 MO		HDM 250		KFG 350
350 MF		HDM 380		KFE 350

THAME WORKHOLDING

Field End, Thame Road, Long Crendon, Aylesbury, Bucks, HP18 9EJ England
 Telephone: + 44 (0)1844 208050 Fax: + 44 (0)1844 201699
 E-mail: sales@thameworkholding.com Web: www.thameworkholding.com

Serrated Soft Top Jaws

90° SERRATIONS

Material:

- Steel: 080M15 (En32) • Black Finish
- Aluminium: HE30TF • Natural Finish

Chuck Ø 125mm - 250mm

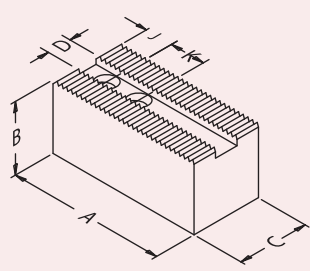

TYPE: **AS**-STEEL **AA** - ALUMINIUM

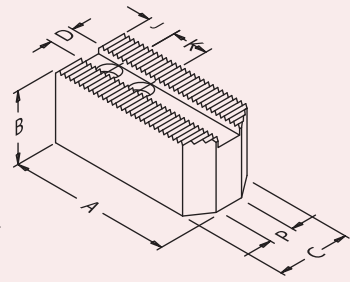

TYPE: **BS** - STEEL

THAME PART No.	JAW TYPE	A	B	C	D	K&J BOLT	P	SERRATIONS	WEIGHT Kg/Set
BV 13	AS	52	25	25	12	14+8 M8		1/16" x 90°	1.0
RD 13	AS	55	40	30	12	16+10 M8		1/16" x 90°	1.2
CL 12	AS	60	30	30		16+15 M8			1.0
BV 16	AS	72	40	30	12	20+10 M10		1/16" x 90°	1.4
CL 17	AS	80	40	30	14	20+19 M10		1/16" x 90°	2.2
BM 16	AS	65	40	40	17	22+15 M12	20	1/16" x 90°	1.3
BN 70	AS	70	60	40		22+15 M12			2.7
BN 75	BS	80	40	40		22+15 M12			2.5
RD 16A	AA	70	60	40		22+15 M12			1.1
CM 16	DS	60	60	120		22+15 M12			9.0
HL 16	DA	64	64	120		22+15 M12			3.2
CM 20	DS	89	64	150		22+15 M12			14.0
HL 20	DA	77	64	150		22+15 M12			5.0
BN 77	ES	80	80	Ø169		22+21.5 M12			13.0
BN 76	EA	80	80	Ø169		22+21.5 M12			6.0
BL 20	AS	64	40	40	17	25.4+13 M12	20	1/16" x 90°	1.6
BL 25	AS	80	50	40		25.4+13 M12			2.8
BN 80	AS	90	40	40		22+15 M12			2.8
BN 85	BS	90	40	40		22+15 M12			2.7
BN 90	AS	90	60	40		22+15 M12			3.7
RD 20A	AA	90	60	40		22+25 M12			1.5
CM 25	DS	102	64	170		22+20 M12			20.0
HL 25	DA	102	64	170		22+20 M12			7.0
BN 87	ES	95	76	Ø210		22+25 M12			21.0
BN 89	EA	99	76	Ø210		22+25 M12			7.0

THAME WORKHOLDING

Field End, Thame Road, Long Crendon, Aylesbury, Bucks, HP18 9EJ England
 Telephone: + 44 (0)1844 208050 Fax: + 44 (0)1844 201699
 E-mail: sales@thameworkholding.com Web: www.thameworkholding.com

IMPORTANT: Allow for weight of Large Diamond/Segment Jaws at high R.P.M.'s as the grip loss due to the effect of centrifugal forces will be greater.

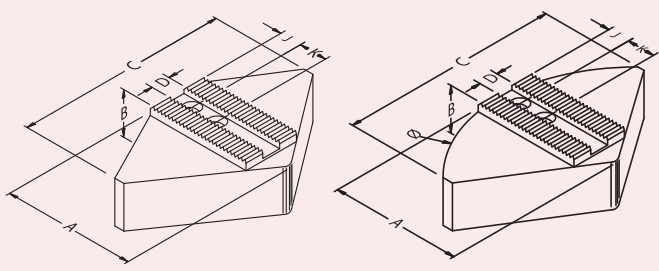

TYPE: **DS** - STEEL **DA** - ALUMINIUM

TYPE: **ES** - STEEL **EA** - ALUMINIUM

AUTOBLOK & SMW - AUTOBLOK	BERG	FORKARDT	GAMET
IN-D 125; AN-D 125; AL-D-125; GHDN 125 PB-D 130; PBI-D 130; BH-D 130; HB-D 130	KF 130	KTH 130; KTH 140	
IDN 170, HDB 170; IDL 170; HDN 170; GHDN 165; GHD-FC 165; AN-D 165; AL-D 165 HFKN-D 165; HYDN--S 180; PB-D 165 PBI-D 165; BB-D 175; BHD-FC 165; HB-D 165			MAC 165/170 DE 170 GA 160/170
AL-D 210; AN-D 210; BB-D 210; BH-D 210 BH-D FC 210; CD 200; GHD-FC 210 GHDN 210; HB-210; HDB 220; HDL 200 IDN 200; IDN 220; IDL 200; HDN 200; HDN 220; HDN 250S; PB-D 210; PBI-D 210 RC-D 210;	KF160; HES160; KHFF 200 KF 200; HES 200; HESF 160 HESF 200;	KGGH 160/175/200; KGGHF 160/175/200 KGG200; KL160; KLNC 200; KP 200 KS 160/200/250; KSF 175/200 KSH 160/200; KSHF 200; KSPS 160/200 KTG 160/200; KTGF 200 KTH 160/ 175/ 200; KTN 160/200 NH 160/175/200; NHF 160/175/200 QLC 160/175/200; QLC-KS 200; QLC-LS 160/200; QLC-AG 200; QLK 160 QLK 175/200; QLK-KS 200; UVE 160/200	MAC 200; MAC 220 DE 210; GA 210
AL-D 210; AN-D 210; BB-D 210; BH-D 210 BH-D FC 210; CD 200; GHD-FC 210 GHDN 210; HB-210; HDB 220; HDL 200 IDN 200; IDN 220; IDL 200; HDN 200; HDN 220; HDN 250S; PB-D 210; PBI-D 210 RC-D 210;	KF 200; HES 200; KHFF 200 HESF 200	KG 200; KGGH 200; KGGHF 200; KLNC 200 KP 200; KS 200/250; KSF 200; KSH 200 KSHF 200/250; KSPS 200; KT 200 KTG 200; KTGF 200; KTH 200; KTN 200 NH 200; NHF 200; QLC 200; QLC-KS 200/250; QLC-AG 200 QLC-LS 160/200; QLK 200; QLK-KS 200/250; UVE 200/250 NHF 250/290 (INDEX)	MAC 200; MAC 220 DE 210; GA 210

THAME WORKHOLDING

Field End, Thame Road, Long Crendon, Aylesbury, Bucks, HP18 9EJ England
 Telephone: + 44 (0)1844 208050 Fax: + 44 (0)1844 201699
 E-mail: sales@thameworkholding.com Web: www.thameworkholding.com

Serrated Soft Top Jaws

90° SERRATIONS

Material:

- Steel: 080M15 (En32) • Black Finish
- Aluminium: HE30TF • Natural Finish

Chuck Ø 125mm - 265mm

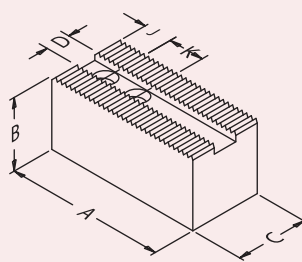

TYPE: **AS** - STEEL **AA** - ALUMINIUM

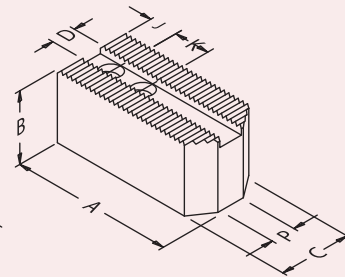

TYPE: **BS** - STEEL

THAME PART No.	JAW TYPE	A	B	C	D	K&J BOLT	P	SERRATIONS	WEIGHT Kg/Set
BV 13	AS	52	25	25	12	14+8 M8		1/16" x 90°	1.0
RD 13	AS	55	40	30	12	16+10 M8		1/16" x 90°	1.2
CL 12	AS	60	30	30		16+15 M8			1.0
BV 16	AS	72	40	30	12	20+10 M10		1/16" x 90°	1.4
CL 17	AS	80	40	30	14	20+19 M10		1/16" x 90°	2.2
BM 16	AS	65	40	40	17	22+15 M12	20	1/16" x 90°	1.3
BN 70	AS	70	60	40		22+15 M12			2.7
BN 75	BS	80	40	40		22+15 M12			2.5
RD 16A	AA	70	60	40		22+15 M12			1.1
CM 16	DS	60	60	120		22+15 M12			9.0
HL 16	DA	64	64	120		22+15 M12			3.2
CM 20	DS	89	64	150		22+15 M12			14.0
HL 20	DA	77	64	150		22+15 M12			5.0
BN 77	ES	80	80	Ø169		22+21.5 M12			13.0
BN 76	EA	80	80	Ø169		22+21.5 M12			6.0
BL 20	AS	64	40	40	17	25.4+13 M12	20	1/16" x 90°	1.6
BL 25	AS	80	50	40		25.4+13 M12			2.8
BN 80	AS	90	40	40		22+15 M12			2.8
BN 85	BS	90	40	40		22+15 M12			2.7
BN 90	AS	90	60	40		22+15 M12			3.7
RD 20A	AA	90	60	40		22+25 M12			1.5
CM 25	DS	102	64	170		22+20 M12			20.0
HL 25	DA	102	64	170		22+20 M12			7.0
BN 87	ES	95	76	Ø210		22+25 M12			21.0
BN 89	EA	99	76	Ø210		22+25 M12			7.0

THAME WORKHOLDING

Field End, Thame Road, Long Crendon, Aylesbury, Bucks, HP18 9EJ England
 Telephone: + 44 (0)1844 208050 Fax: + 44 (0)1844 201699
 E-mail: sales@thameworkholding.com Web: www.thameworkholding.com

IMPORTANT: Allow for weight of Large Diamond/Segment Jaws at high R.P.M.'s as the grip loss due to the effect of centrifugal forces will be greater.

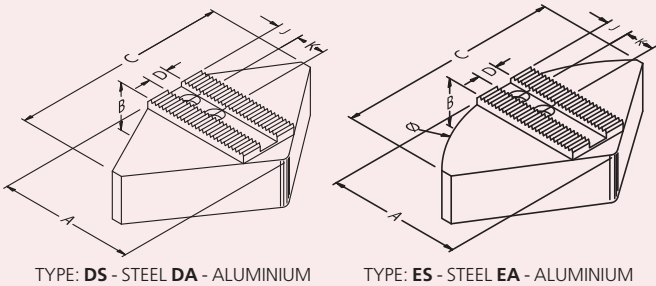

PRATT BURNERD	RÖHM	SCHUNK	SMW
125 INTERNATIONAL 150 KB INTERNATIONAL			
170 KB INTERNATIONAL	KFD 130; KFD-HE 170; KFH 140 KFD-HS 160/175; LVE 125/160	HSG 160; ROTA NCD 160/165	KDV 130 KMA 140 KMAF 140
135 HYD. FRONT END 165 INTERNATIONAL 165 CONSTANT GRIP 165 HIGH SPEED QC			
			SP 160
160 INTERNATIONAL 160 HIGH SPEED QC 165 HYD. FRONT END 210 INTERNATIONAL 210 HIGH SPEED QC 210 KB INTERNATIONAL 210 KB HIGH SPEED QC 210 CONSTANT GRIP	KFD 160; KFD-AF 160; KFD-HF 160; KFD-HS 200; KFH 160; KFH-F 160; KFH-G 160; KFH-HC 160 SPD 160; SPO 160	HSL 165 ROTA NC 165 ROTA NCD 185 ROTA NCF 165 TH 165 THF 165	HKKS 160/200 KDV 160/200/250 KDBG 160/200/250 KDM 160/200 KDM-F 160/200/250 KMA 160/200/250 KMAF 160/200/250 KFV160/200 SP 200 KFMF 160/200 HFK 160/200
200 INTERNATIONAL 200 HIGH SPEED QC 210 HYD. FRONT END 250 HIGH SPEED QC 254 INTERNATIONAL 265 HIGH SPEED QC 265 KB INTERNATIONAL 265 KB HIGH SPEED QC 254 CONSTANT GRIP	KFD 200; KFD-AF 200; KFD-HE 200; KFD-HF 200 KFD-HS 250; KFH 200; KFH-F 200 KFH-G 200; KFH-NC 200 KFL 250; LVE 200; SPD 215; SPO 215	HSL 210 ROTA NC 210; ROTA NCD 210 ROTA NCF 210; ROTA NCO 210; ROTA TP 200; TH 210; THF 210 TP 200; ROTA NCK 210/250 ROTA NC plus 215; ROTA NCF plus 215	HFKS 200 KDV 200/250 KDBG 200/250 KDM 200 KDM-F 200/250 KMA 200/250 KMA-F 200/250 KFV 200 KFMF 200 HFK 200

THAME WORKHOLDING

Field End, Thame Road, Long Crendon, Aylesbury, Bucks, HP18 9EJ England
 Telephone: + 44 (0)1844 208050 Fax: + 44 (0)1844 201699
 E-mail: sales@thameworkholding.com Web: www.thameworkholding.com

Serrated Soft Top Jaws

90° SERRATIONS

Material:

- Steel: 080M15 (En32) • Black Finish
- Aluminium: HE30TF • Natural Finish

Chuck Ø 250mm - 800mm

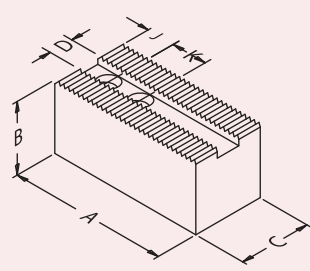

TYPE: AS- STEEL AA - ALUMINIUM

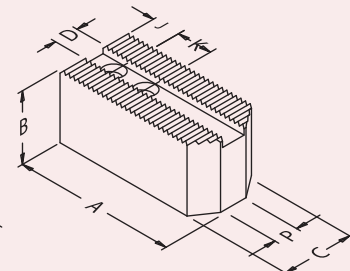

TYPE: BS - STEEL

THAME PART No.	JAW TYPE	A	B	C	D	K&J BOLT	P	SERRATIONS	WEIGHT Kg/Set
BL 32	AS	105	60	40	21	31.8+16 M16		1/16" x 90°	5.0
BM 32	AS	116	60	50		31.8+16 M16			7.6
BN 10	AS	120	50	50		28+20 M16			5.4
BN 11	BS	120	50	50		28+20 M16	24		5.3
BN 12	AS	120	80	50		28+30 M16			9.4
BN 14	AS	140	50	50		28+20 M16			6.3
BN 15	BS	140	50	50		28+20 M16	24		6.2
RD 25A	AA	120	80	50		28+30 M16			6.2
CM 26	DS	102	64	170		28+20 M16			20.0
HL 26	DA	103	64	170		28+20 M16			7.0
BN 17	ES	122	76	Ø254		28+28 M16			29.0
BN 19	EA	122	76	Ø254		28+28 M16			10.0
CM 32	DS	132	76	240		28+30 M16			28.0
HL 32	DA	132	76	240		28+30 M16			10.0
BN 13	AS	140	90	60	25.5	35+30 M20		1/16" x 90°	15.0
BM 40	AS	152	80	60	25.5	44.5+20 M20		3/32" x 90°	14.3
BN 23	AS	155	90	60		35+30 M20			17.4
RD 40A	AA	155	102	64		30+35 M20			6.5
CM 40	DS	153	76	280		35+32 M20			48.0
HL 40	DA	151	76	280		35+32 M20			16.0
BN 27	ES	178	76	Ø400		35+53 M20			64.0
BN 29	EA	178	76	Ø400		35+53 M20			21.0
BJ 50	AS	146	80	50	25.4	44.5+29 M20		3/32" x 90°	12.6
CL 50	AS	160	80	60	28	38+25 M20		3/32" x 90°	14.5

THAME WORKHOLDING

Field End, Thame Road, Long Crendon, Aylesbury, Bucks, HP18 9EJ England
 Telephone: + 44 (0)1844 208050 Fax: + 44 (0)1844 201699
 E-mail: sales@thameworkholding.com Web: www.thameworkholding.com

IMPORTANT: Allow for weight of Large Diamond/Segment Jaws at high R.P.M.'s as the grip loss due to the effect of centrifugal forces will be greater.

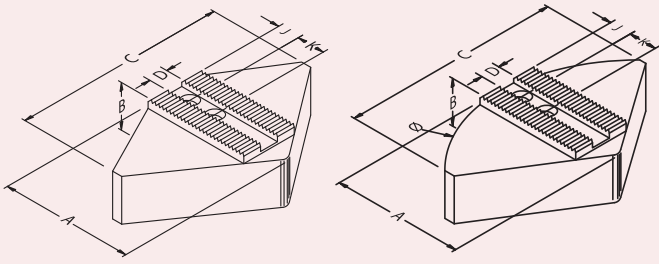

TYPE: **DS** - STEEL **DA** - ALUMINIUM

TYPE: **ES** - STEEL **EA** - ALUMINIUM

AUTOBLOK & SMW - AUTOBLOK	BERG	FORKARDT	GAMET
IDN 250; IDN 315; IDN 400; IDL 250; IDL 315 IDL 400; HDN 250; HDN 315; HDN 400 GHDN 250; GHDN 315; GHDN 400; CD 250 CD 315; GHD-FC 250; GHD-FC 305; GHD-FC 400; HDB 300; AN-D 250 AL-D 250; AN-D 315; AL-D 315; BB-D 250; BB-D 315; BH-D 250; BH-D 315 GH-D 400; HB-D 250; HB-D 315; HDB 300 HDL 250; HDL 315; HDL 400; HDN 250 HDN 315; HDN 400; HYDN-S 250; HYDN-S 315 PB-D 250; PB-D 315; PBI-D 250; PBI-D 315 RC-D 250; RC-D 305; RC-D 400	KF 250; HES 250; KHFF 250 HESF 250; KF 315; HES 315 KHFF 315; HESF 315	KG 250/315; KL 250; KLNC 250/315 KP 250/315; KS 315/400 KSH 250/315/400 KSHK 250/315/400; KSPS 250/300 KT 250/315; KTG 250/315; KTGF 250/315 KTN 250/315; NH 250/315; NHF 250/315 QLC 250/315; QLC-KS 315/400 QLC-LS 250/315; QLC-AG 250/315 QLK 250/315; QLK-KS 315/400 UVE 315; NHF 400(INDEX)	MAC 250; MAC 315 DE 250/260/320 GA 250/315
		KL 300; KSHF 560	MAC 380
IDN 500; IDN 630; IDN 800 IDL 500; IDL 630; IDL 800 GHDN 500; GHDN 610; GHDN 640; GHDN 800 AL-D 400; AN-D 400 GH-D 500; GH-D 610; GH-D 800 IN-D 500; IN-D 630; IN-D 800 BB-N 400; BB-N 460; BB-N 500 BH-D 400; BH-D 450; BH-D 500; BH-D 630 BH-D 800; BHD-FC 500; BHD-FC 630	KF 400; KF 500; KF630 HES 400; HES 500; HES 630 KHFF 400; KFF 400; KFF 400; KFF 500; KFF 630; HESF 400; HESF 500; HESF 630	KG 400/500; KL 400/500; KLNC 400/500 KP 400/500; KS 500/630 KSH 500; KSHF 630; KSL 630 KS-PS 400; KTG 400/500/630 KTGF 400/500/630; KTN 400/500/630 NH 400/500/630; NHF 400/500/630 QLC 400; QLK 400; UVE 400/500/630/800	DE 400
IDN 500; IDN 630; IDN 800 (all pre 94) GHDN 500/610/640/800; HDL 500/630/800			

THAME WORKHOLDING

Field End, Thame Road, Long Crendon, Aylesbury, Bucks, HP18 9EJ England
 Telephone: + 44 (0)1844 208050 Fax: + 44 (0)1844 201699
 E-mail: sales@thameworkholding.com Web: www.thameworkholding.com

Serrated Soft Top Jaws

90° SERRATIONS

Material:

- Steel: 080M15 (En32) • Black Finish
- Aluminium: HE30TF • Natural Finish

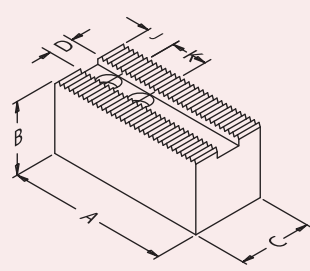

TYPE: AS- STEEL AA - ALUMINIUM

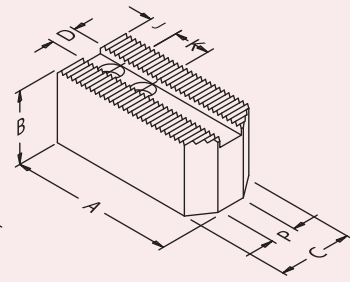

TYPE: BS - STEEL

Chuck Ø 250mm - 1000mm

THAME PART No.	JAW TYPE	A	B	C	D	K&J BOLT	P	SERRATIONS	WEIGHT Kg/Set
BL 32	AS	105	60	40	21	31.8+16 M16		1/16" x 90°	5.0
BM 32	AS	116	60	50		31.8+16 M16			7.6
BN 10	AS	120	50	50		28+20 M16			5.4
BN 11	BS	120	50	50		28+20 M16	24		5.3
BN 12	AS	120	80	50		28+30 M16			9.4
BN 14	AS	140	50	50		28+20 M16			6.3
BN 15	BS	140	50	50		28+20 M16	24		6.2
RD 25A	AA	120	80	50		28+30 M16			6.2
CM 26	DS	102	64	170		28+20 M16			20.0
HL 26	DA	103	64	170		28+20 M16			7.0
BN 17	ES	122	76	Ø254		28+28 M16			29.0
BN 19	EA	122	76	Ø254		28+28 M16			10.0
CM 32	DS	132	76	240		28+30 M16			28.0
HL 32	DA	132	76	240		28+30 M16			10.0
BN 13	AS	140	90	60	25.5	35+30 M20		1/16" x 90°	15.0
BM 40	AS	152	80	60	25.5	44.5+20 M20		3/32" x 90°	14.3
BN 23	AS	155	90	60		35+30 M20			17.4
RD 40A	AA	155	100	60		30+35 M20			6.5
CM 40	DS	153	76	280		35+32 M20			48.0
HL 40	DA	151	76	280		35+32 M20			16.0
BN 27	ES	178	76	Ø400		35+53 M20			64.0
BN 29	EA	178	76	Ø400		35+53 M20			21.0
BJ 50	AS	146	80	50	25.4	44.5+29 M20		3/32" x 90°	12.6
CL 50	AS	160	80	60	28	38+25 M20		3/32" x 90°	14.5

THAME WORKHOLDING

Field End, Thame Road, Long Crendon, Aylesbury, Bucks, HP18 9EJ England
 Telephone: + 44 (0)1844 208050 Fax: + 44 (0)1844 201699
 E-mail: sales@thameworkholding.com Web: www.thameworkholding.com

IMPORTANT: Allow for weight of Large Diamond/Segment Jaws at high R.P.M.'s as the grip loss due to the effect of centrifugal forces will be greater.

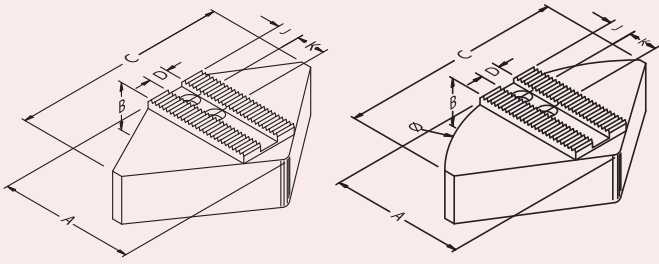

TYPE: **DS** - STEEL **DA** - ALUMINIUM

TYPE: **ES** - STEEL **EA** - ALUMINIUM

PRATT BURNERD	RÖHM	SCHUNK	SMW
250 INTERNATIONAL 254 HYD. FRONT END 305 HYD. FRONT END 305 INTERNATIONAL 305 HIGH SPEED QC 315 INTERNATIONAL 400 HIGH SPEED QC 305 KB INTERNATIONAL 305 KB HIGH SPEED QC 305 CONSTANT GRIP	KFD 250/315; KFD-AF 250/315 KFD-HE 254/315 KFD-HF 250/315 KFD-HS 315 KFH 250/315; KFH-F 250/315 KFH-G 250/315 KFH-NC 250/315 KFL 250/315 LVE 250/305/315 SPD 300; SPO 300	HSL 250; HSL 315; ROTA NC 250/315 ROTA NC plus 260/315; ROTA NCD 250; ROTA NCD 315 ROTA NCF 250; ROTA NCF 315 ROTA NCF plus 260/315 ROTA NCK plus 315 ROTA NCO 260/315 ROTA TP 250; ROTA TP 315 TH 250/315; THF 250/315	HFK 250/315 HFKS 250/315 KDV 315/400 KDBG 315/400 KDM 250/315/400 KDM-F 315/400 KMA 315/400 KMA-F 315
400 INTERNATIONAL 400 HYD. FRONT END 500 HYD. FRONT END	KFD 400/500/630/800 KFD-HE 400 KFD-HF 400/500/630 KFD-HS 400/500 KFH 400/500; KFH-F 400/500 KFH-G 400/500 KFH-NC 400/500 KFL 500/600 LVE 400/500/630/800/1000	HSG 400-500; HSL 400; ROTA NC 400 ROTA NC 500; ROTA NCD 400/500 ROTA NCF 400/500 ROTA NCO 400/500 TH 400; TH 500 THF 400; THF 500	HFK 400/500 HFKS 400/500 KDV 500 KDBG 500 KDM 500 KFV 400/500/630/800
380 INTERNATIONAL 380 HIGH SPEED QC			

THAME WORKHOLDING

Field End, Thame Road, Long Crendon, Aylesbury, Bucks, HP18 9EJ England
 Telephone: + 44 (0)1844 208050 Fax: + 44 (0)1844 201699
 E-mail: sales@thameworkholding.com Web: www.thameworkholding.com

Serrated Soft Top Jaws

90° SERRATIONS

Material:

- Steel: 080M15 (En32)
- Black Finish

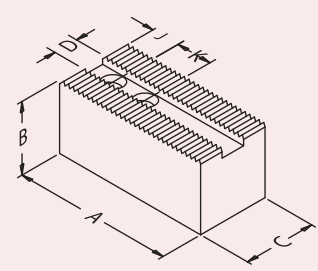

TYPE: AS - STEEL

To suit • SMW-Autoblok Large & Extra Large Open Centre Power Chucks

THAME PART No.	JAW TYPE	A	B	C	D	K&J BOLT	SERRATIONS	WEIGHT Kg/Set	SMW-AUTOBLOK
CL 12	AS	60	30	30	12	16+15	1/16" x 90°	1.0	BH-D 130 BB-D 140
CI 12	AS	60	50	30		M8		1.6	AL-D 125 AN-D 125
CH 17	AS	70	40	30	14	16.5+16	1/16" x 90°	1.3	BH-D 165; BHD-FC 175; BB-D 175
CI 17	AS	70	60	30		M10		1.9	RC-D 165 AL-D 165 AN-D 165
CH 21	AS	90	40	40	17	23+20	1/16" x 90°	2.8	BH-D 210, BHD-FC 210; BBD 210
CI 21	AS	90	60	40		M12		4.2	RC-D 210 AL-D 210 AN-D 210
CH 25	AS	110	50	50	21	30+20	1/16" x 90°	3.8	BH-D 250, BHD-FC 250; BB-D 250
CI 25	AS	110	70	50		M16		5.3	RC-D 250 AL-D 250 AN-D 250
CH 32	AS	125	50	50	21	30+20	1/16" x 90°	5.5	BH-D 315; BND-FC 315; BB-D 315
CI 32	AS	125	80	50		M16		8.8	RC-D 315 AL-D 315 AN-D 315

To suit • Berg KH, KV & KHL Power Chucks

THAME PART No.	JAW TYPE	A	B	C	D	K&J BOLT	SERRATIONS	WEIGHT Kg/Set	BERG
CS 11	AS	55	40	20	8	14+11 M8	1/16" x 90°	0.7	KH 110
CS 16	AS	70	50	25	10	20+15		1.4	KH 140-36; KH 140-45; KH 160
CS 17	AS	70	60	25		M10		1.8	KV 160; KHL 160
CS 18	AS	80	60	30	12	21+15 M12		3.6	KH 175-56; KH 200-68 KV 200; KHL 200
CS 20	AS	90	60	30	12	21+15 M12		3.8	KH 175-56; KH 200-68 KV 200; KHL 200
CS 25	AS	111	60	40	16	29+18		4.7	KH 250-91; KH 315-117
CS 26	AS	113	80	40		M16		6.2	KV 250; KV 315; KHL 250; KHL 315
CS 40	AS	150	80	50	20	38+31 M20	3/32" x 90°	8.4	KH 400; KH 500; KH 630 KV 400; KHL 400

THAME WORKHOLDING

Field End, Thame Road, Long Crendon, Aylesbury, Bucks, HP18 9EJ England
 Telephone: + 44 (0)1844 208050 Fax: + 44 (0)1844 201699
 E-mail: sales@thameworkholding.com Web: www.thameworkholding.com

Serrated Soft Top Jaws

90° SERRATIONS

- Material:
- Steel: 080M15 (En32)
 - Black Finish

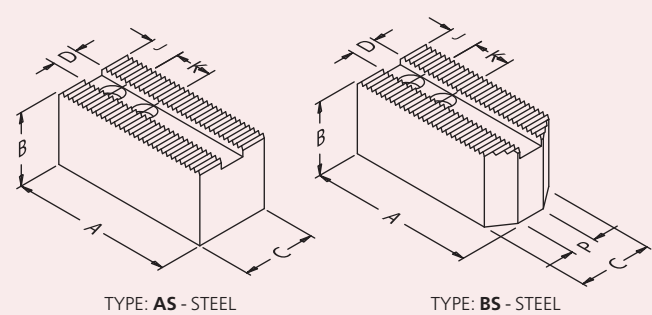

To suit • Röhms KFD-HS
 • Schunk HSG Power Chucks

THAME PART No.	JAW TYPE	A	B	C	D	K&J BOLT	P	SERRATIONS	WEIGHT Kg/Set	RÖHM	SCHUNK
BI 13	BS	53	30	25	10	12+12+9 M6	3	1/16" x 90°	0.8	KFD-HS 130 KFD-HS 140	HSG 140
BI 14	BS	53	50	25	10	12+12+9 M6	3	1/16" x 90°	1.1	KFD-HS 130 KFD-HS 140	
BI 16	AS	55	40	30	12	15+9			1.9	KFD-HS 160 KFD-HS 175	HSG 160
BI 17	AS	55	60	30		M8			2.8		
BI 20	AS	70	60	40	17	19+12 M12			3.1	KFD-HS 200	HSG 200
BI 25	AS	90	60	40	17	19+12 M12			4.2	KFD-HS 250	HSG 250
BI 32	AS	105	60	50	21	25+15 M16			6.0	KFD-HS 315	HSG 315
BI 40	AS	140	90	60	25.5	31+20 M20		3/32" x 90°	14.5	KFD-HS 400 KFD-HS 500 HSG 500	HSG 400

To suit • Pratt Burnerd Constant Grip Power Chucks

THAME PART No.	JAW TYPE	A	B	C	D	K&J BOLT	SERRATIONS	WEIGHT Kg/Set	PRATT BURNERD
BL 16	AS	50	40	30	15	20.6+11 M10	1/16" x 90°	1.0	160 TYPES 1770-/1771-/1772-
BL 20	AS	64	40	40	17	25.4+13 M12		1.6	200 TYPES 1770-/1771-/1772-
BL 25	AS	80	50	40	17	25.4+13 M12		2.8	250 TYPES 1770-/1771-/1772-
BL 32	AS	105	60	40	21	31.8+17 M16		5.0	315 TYPES 1770-/1771-/1772-
BL 40	AS	124	60	50	21	38.1+17 M16	3/32" x 90°	8.4	380 TYPES 1770-/1771-/1772-

Serrated Soft Top Jaws

90° SERRATIONS

Material:

- Steel: 080M15 (En32)
- Black Finish

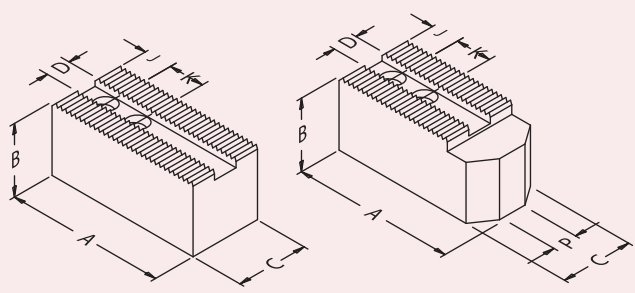

To suit • Schunk • SMW-Autoblok Pneumatic Power Chucks

THAME PART No.	JAW TYPE	A	B	C	D	K&J BOLT	SERRATIONS	WEIGHT Kg/Set	SMW-AUTOBLOK	SCHUNK
CO 13	AS	68	40	30	11	18+21 M8	1/16" x 90°	1.6	SP 125/ STP 125/ STWP 125	TP 125
CO 16	AS	88	50	30	14	25+25 M10		2.9	SP 160/ STP 160/ STWP 160	TP 160
CO 20	AS	98	50	40	17	29+25 M12		4.0	SP 200 / STP 200 / LP 205 / STWP 200	TP 200
CO 25	AS	108	70	50	21	30+28 M14		8.0	SP 250 / STP 250 / LP 250 / STWP 250 SP315/ STP315/ LP305/ STWP315	TP 250/315
CO 32	AS	120	70	50	21	30+28 M14		10.1	SP315/ STP315/ LP305/ STWP315	TP 315
CO 35	AS	132	70	50	21	30+28 M14		11.5	SP315/ STP315/ STWP315	

To suit • Gamet Power Chucks

THAME PART No.	JAW TYPE	A	B	C	D	K&J BOLT	P	SERRATIONS	WEIGHT Kg/Set	GAMET
BU 06	CS	77	35	25	11	20+9 M8	7	1/16" x 90°	1.1	160N / 160 MO / 160GP
BU 08	CS	102	40	30	14	22+10 M10	10		2.6	215 N / 215 MO / 215 GP
BU 11	CS	130	50	40	20	30+13 M12	10		5.4	250/280 N / 280 MO / 280 GP
BU 14	CS	170	60	50	21	40+22 M16	18		10.0	350 N / 350 MO / 350 GP

Serrated Soft Top Jaws

90° SERRATIONS

Material:

- Steel: 080M15 (En32)
- Black Finish

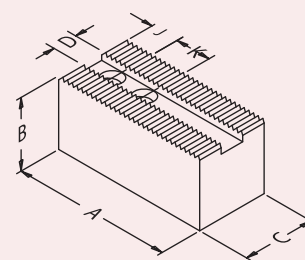

TYPE: AS - STEEL

To suit • Coventry • Tudor Manual Chucks

THAME PART No.	JAW TYPE	A	B	C	D	K&J BOLT	SERRATIONS	WEIGHT Kg/Set	COVENTRY	TUDOR
AJ 06	AS	57	30	25	12.7	12.7+16	1/16" x 90°	0.9	6" & 7 1/2" Coventry	6 1/2" Tudor
AL 06	AS	67	50	25		5/16 BSW		1.8		
AJ 07	AS	64	30	25	14.3	17.5+21	1/16" x 90°	1.2		7 1/2" Tudor
AL 07	AS	76	50	25		3/8 BSW		2.1		
AJ 09	AS	70	40	30	15.9	15.9+21	1/16" x 90°	1.9	9" Coventry	9" Tudor
AL 09	AS	82	70	30		7/16 BSW		3.5		
AJ 12	AS	76	50	40	17.5	23+19	1/16" x 90°	2.8	12" Coventry	12" Tudor
AL 12	AS	102	80	40		1/2 BSW		5.7		
AJ 15	AS	95	60	40	20.6	30.2+25.4	1/16" x 90°	4.4	15" Coventry	15" Tudor
AL 15	AS	121	90	40		5/8 BSW		9.0		
AJ 18	AS	108	60	50	25.4	34.9+27	3/32" x 90°	7.0	18" Coventry	18" Tudor
AL 18	AS	140	90	50		3/4 BSW		12.9		
AJ 21	AS	140	80	50	25.4	41.3+43	3/32" x 90°	12.0	21" Coventry	21" Tudor
AL 21	AS	171	125	50		3/4 BSW		24.0		
AJ 25	AS	155	80	50	25.4	54+41	3/32" x 90°	14.3	25" Coventry	25" Tudor
AL 25	AS	197	125	50		3/4 BSW		33.2		

THAME WORKHOLDING

Field End, Thame Road, Long Crendon, Aylesbury, Bucks, HP18 9EJ England
 Telephone: + 44 (0)1844 208050 Fax: + 44 (0)1844 201699
 E-mail: sales@thameworkholding.com Web: www.thameworkholding.com

Serrated Soft Top Jaws

90° SERRATIONS

Material:

- Steel: 080M15 (En32)
- Black Finish

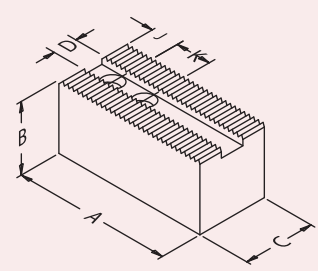

TYPE: AS - STEEL

To suit • Autoblok • Forkardt • Röhms
• Schunk • SMW 2 Jaw Chucks

THAME PART No.	JAW TYPE	A	B	C	D	K&J BOLT	SERRATIONS	WEIGHT Kg/Set
DS 20	AS	95	70	70	21	27+22 M16	1/16" x 90°	7.2
DS 25	AS	110	70	70	25.5	35+20 M20	1/16" x 90°	7.6
DS 32	AS	125	80	80	25.5	35+28 M20	1/16" x 90°	10.6
DS 40	AS	150	80	80	25.5	35+28 M20	1/16" x 90°	13.0

To suit • Schunk • SMW-Autoblok Big Bore Power Chucks

THAME PART No.	JAW TYPE	A	B	C	D	K&J BOLT	SERRATIONS	WEIGHT Kg/Set
CP 40	AS	155	80	60	25.5	40+35 M20	3/32" X 90°	15.0
CP 50	AS	185	80	60	25.5	40+35 M20	3/32" X 90°	18.0
CP 63	AS	240	102	76	30	64+40 M24	3/32" X 90°	35.0
CP80	AS	300	102	76	30	64+40 M24	3/32" X 90°	43.0

Serrated Soft Top Jaws

90° SERRATIONS

Material:

- Steel: 080M15 (En32)
- Black Finish

AUTOBLOK	FORKARDT	ROHM	SCHUNK	SMW
2CLD 200	2BLE 200	KFD-G-200 KFA 200	2B 200	KZF 200
2CLD 250	2BLE 250	KFD-G-250 KFA 250	2B 250	KZF 250
2CLD 315	2BLE 315	KFD-G-315 KFA315	2B 315	KZF 315
	2BLE 400 2BLE 500	KFD-G-400	2B 400	KZF 400

SMW-AUTOBLOK	SCHUNK
BB400 / BB400-ES / STP 400 / LP 380-460	ROTA EP 380 ROTA TB 400 TB 400
BB500 / BB500-ES, BB630-ES265 LP 500 / STP 500	ROTA EP 460 ROTA TB 500/ 610 ROTA TB 630-265 LH TB 500
BB630 / BB630-ES325 / STP 630 BB-N 630	ROTA NC 630 ROTA TB 630-265 LH ROTA TB 630-310 ROTA TB 630-325LH
BB800 / BB 1000 / STP 800 BB850-1000 ES BB-N 800/1000	ROTA TB800/850/1000/1200 TB 800/1000/1200

THAME WORKHOLDING

Field End, Thame Road, Long Crendon, Aylesbury, Bucks, HP18 9EJ England
 Telephone: + 44 (0)1844 208050 Fax: + 44 (0)1844 201699
 E-mail: sales@thameworkholding.com Web: www.thameworkholding.com